

Inseego Wavemaker™ PRO 5G Industrial Gateway S2000e



INSEEGO COPYRIGHT STATEMENT

© 2022 Inseego Corp. All rights reserved. Complying with all copyright laws is the responsibility of the user. Without limiting the rights under copyright, no part of this document may be reproduced, stored in or introduced into a retrieval system, or transmitted in any form or by any means (electronic, mechanical, photocopying, recording or otherwise), or for any purpose without the expressed written permission of Inseego Corp.

SOFTWARE LICENSE

Proprietary Rights Provisions:

Any software drivers provided with this product are copyrighted by Inseego Corp. and/or Inseego Corp.'s suppliers. Although copyrighted, the software drivers are unpublished and embody valuable trade secrets proprietary to Inseego Corp. and/or Inseego Corp. suppliers. The disassembly, decompilation, and/or Reverse Engineering of the software drivers for any purpose is strictly prohibited by international law. The copying of the software drivers, except for a reasonable number of back-up copies is strictly prohibited by international law. It is forbidden by international law to provide access to the software drivers to any person for any purpose other than processing the internal data for the intended use of the software drivers.

U.S. Government Restricted Rights Clause:

The software drivers are classified as "Commercial Computing device Software" and the U.S. Government is acquiring only "Restricted Rights" in the software drivers and their Documentation.

U.S. Government Export Administration Act Compliance Clause:

It is forbidden by US law to export, license or otherwise transfer the software drivers or Derivative Works to any country where such transfer is prohibited by the United States Export Administration Act, or any successor legislation, or in violation of the laws of any other country.

TRADEMARKS AND SERVICE MARKS

Inseego Corp. is a trademark of Inseego Corp., and the other trademarks, logos, and service marks (collectively the "Trademarks") used in this user manual are the property of Inseego Corp. or their respective owners. Nothing contained in this user manual should be construed as granting by implication, estoppel, or otherwise, a license or right of use of Inseego Corp. or any other Trademark displayed in this user manual without the written permission of Inseego Corp. or its respective owners.

- MiFi® and the MiFi logo are registered trademarks of Inseego Corp.
- Microsoft and Windows are either registered trademarks or trademarks of Microsoft Corporation in the United States and/or other countries.
- Linux® is the registered trademark of Linus Torvalds in the U.S. and other countries.

The names of actual companies and products mentioned in this user manual may be the trademarks of their respective owners.

Document Number: 90029653 Rev 6

Contents

1 Introduction and Getting Started	5
Overview.....	6
Key Features	6
Description.....	7
Front View	7
Back View.....	7
Indicator LEDs.....	8
Getting Started.....	9
Installing a SIM Card	9
Installation Options	10
Identifying a Location	12
Connecting Antennas	12
Power Options.....	13
Connecting Devices to the Gateway	15
Monitoring and Managing your Gateway	16
Common Problems and Solutions	16
I cannot access the Admin Web UI.....	16
My connecting device is not obtaining a valid IP address.....	16
Resetting your Gateway.....	18
Resetting with the RESET Button	18
Resetting from the Inseego Mobile App	19
Resetting from the Admin Web UI	19
Resetting from Inseego Connect	19
Technical Support	19
2 Configuration	20
Overview.....	21
Home Page.....	22
Side Menu	22
Header Icons.....	23
Getting Help	23
Admin Password.....	24
Changing the Admin Password.....	24
Managing Data Usage	25
Data Usage Page.....	26
Managing Settings.....	28
Preferences Tab.....	28
Software Update Tab	29
Backup and Restore Tab.....	31
GPS Tab	33
VPN Tab.....	38
GPIO Tab	40
Advanced Tab.....	42
Viewing Info About the Gateway.....	43
Internet Status Tab.....	44
Internet Sessions Tab	45
Diagnostics Tab.....	46
Device Info Tab.....	47
Logs Tab.....	48
Getting Support	49

Customer Support Tab	49
3 Advanced Settings.....	50
Overview.....	51
Using Advanced Settings	51
Cellular Tab	52
Manual DNS Tab	53
SIM Tab.....	54
LAN Tab.....	59
WAN.....	61
Firewall Tab.....	62
MAC Filter Tab	63
Port Filtering Tab	64
Port Forwarding Tab.....	67
Insego Connect Tab	70
HTTPS Tab	71
Remote Admin Tab	74
4 Accessories	75
Included Accessories.....	76
Optional Accessories.....	76
5 Product Specifications and Regulatory Information.....	77
Product Specifications	78
Device	78
Environmental	79
Cellular Technology.....	79
Bluetooth.....	79
Positioning	79
Networking	80
Security.....	80
Regulatory Information.....	81
Product Certifications and Supplier’s Declarations of Conformity.....	86
Wireless Communications.....	86
Limited Warranty and Liability.....	87
Safety Hazards	88
6 Glossary	89
Glossary.....	90

1

Introduction and Getting Started

Overview

Description

Indicator LEDs

Getting Started

Description

Resetting your Gateway

Technical Support

Overview

The 5G Industrial Gateway S2000e delivers ultra-reliable cellular Internet service with 5G NR connectivity. The S2000e supports any public or private network while also supporting all carriers. It connects to any routing system or remote endpoint with Ethernet or USB. The S2000e provides continuous multi-Gigabit connectivity and sub-second latency for enterprise settings.



Key Features

- Ultra-reliable global connectivity with support for public or private networks and all major carriers in North America, Europe, and APAC.
- Multi-gig speeds for any enterprise needs, such as large file transfers or multiple 4k video streams.
- Sub-millisecond latency allow rapid communications and reactions to changes in remote or factory automation applications.
- Class-leading thermal design allows for operation in extreme temperatures from -30°C to 65°C (-22 to 158°F) while running multi-gigabit throughput.
- Support for up to two SIMS with automatic switching based on network availability and/or signal strength.
- Complete device management, visibility, and security with the Inseego Manage software suite.

Description

Inside the box you will find a 5G Industrial Gateway S2000e, a 4-pin power cable, and a SIM tool. Additional accessories, including antennas, brackets, and other power equipment, are available for individual purchase. See Chapter 4, Accessories, for a list of accessories. To order an accessory, contact your Inseego sales representative.

Front View

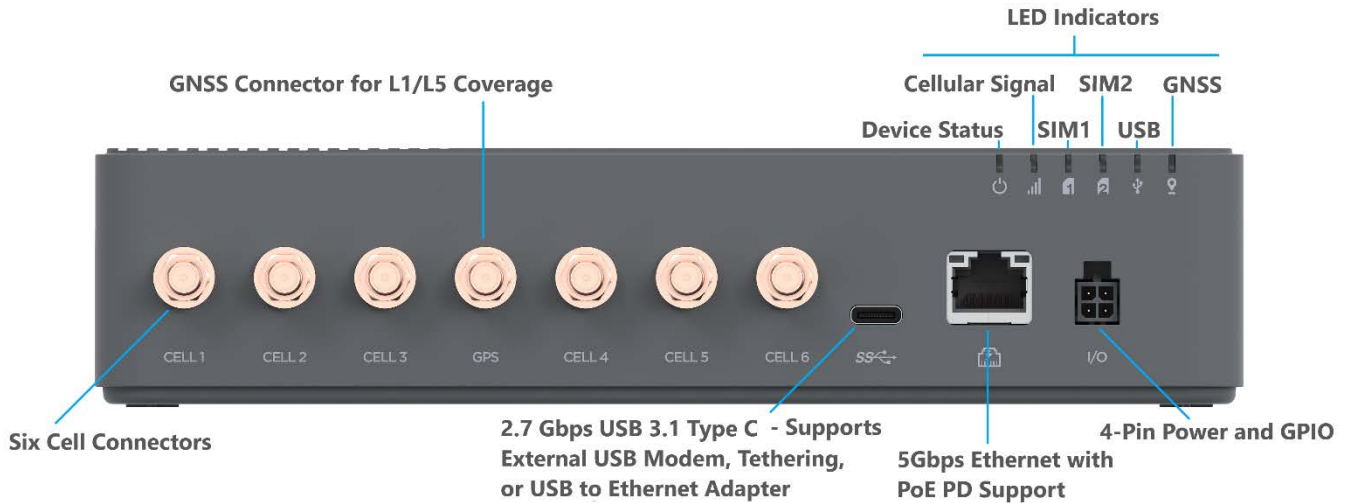

Back View

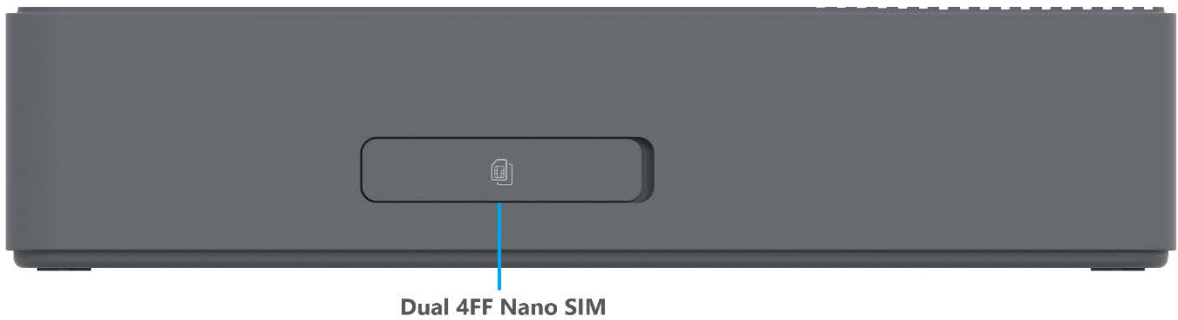

Indicator LEDs

The S2000e has indicator LEDs that communicate current states for the device.

LED	LED Color	Operation	Meaning
Device Status	White	Solid Slow Blink*	Starting Up or Updating Low Power Mode
	Red	Solid	Device On, No Connection
	Yellow	Solid	Device On, External Connection
	Green	Solid	Device On, Internal LTE Connection
	Blue	Solid	Device On, Internal 5G Connection
Cellular Signal	Red	Solid	RSRP \geq -102 dBm
	Yellow	Solid	RSRP -90 dBm - -102 dBm
	Green	Solid	RSRP -80 dBm - -90 dBm
	Blue	Solid	RSRP \leq -80 dBm
SIM (SIM1 and SIM2)	Off	Off	No SIM
	Red	Solid	SIM Error
	Yellow	Solid Blinking [†]	SIM Installed, Slot Inactive SIM Installed, Slot Active, Not Connected
	Green	Solid	SIM Installed, Slot Active, Connected
USB	Off	Off	No USB
	Red	Solid	USB Error
	Yellow	Solid Blinking	USB Connected, Not Active USB Active, Not Connected
	Green	Solid	USB Connected, Active
GNSS	Off	Off	No SIM
	Red	Solid	GPS Error
	Yellow	Blinking	Searching/Acquiring
	Green	Solid	Signal Acquired

The Ethernet connector port also has an indicator LED.

LED	Color	Operation	Meaning
Ethernet Speed	Green	Solid	5GbE
	Yellow	Solid	100Mbps – 2.5GbE
Ethernet Activity	Green	Solid	No activity
		Blinking	Activity

* Slow Blink is one second on, five seconds off.

† Blinking is one second on, one second off.

Getting Started

This section provides instructions for getting your S2000e up and running, as well as reset and support information.

Installing a SIM Card

Your SIM card is a small rectangular plastic card that stores your phone number and important information about your wireless service. The S2000e supports only Nano SIM cards.



CAUTION! Always use a factory-made SIM card supplied by the service provider. Do not bend or scratch your SIM card. Avoid exposing your SIM card to static electricity, water, or dirt.

To install a SIM card:

1. Lift the tab to open the SIM cover on the back of the device.



2. If necessary, remove the SIM card from the protective sleeve, being careful not to touch the gold colored contacts.
3. Use the SIM end of the included SIM tool to insert the SIM card into the appropriate SIM slot **notch first, with the gold-colored contact points facing down**. **NOTE:** The SIM card will click when properly installed.



4. Close the SIM cover.

NOTE: When replacing a SIM card, use the SIM end of the provided SIM tool to remove the existing SIM card. Should your SIM card be lost or damaged, contact your network operator.

Installation Options

You can install the S2000e to a wall or pole, or in a cabinet or enclosure. **NOTE:** See Chapter 4, Accessories for optional mounting accessories.

The S2000e has integrated mounting points that allow you to mount to a wall or pole with brackets.

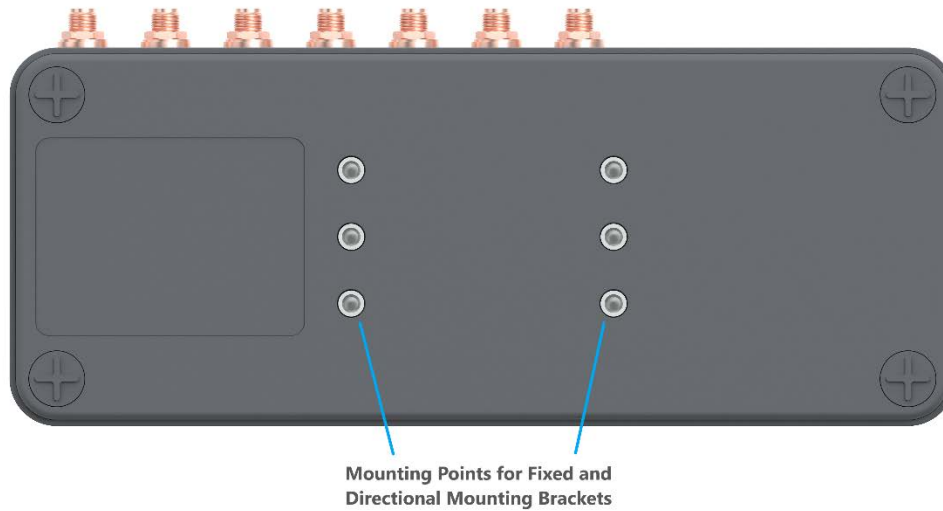

Fixed Wall Mount Bracket

You can use a fixed bracket when installing your S2000e on a wall or pole.



Adjustable Wall Mount Bracket

You can use an adjustable bracket when installing your S2000e on a wall or pole. An adjustable bracket allows you to point your S2000e directly at an indoor 5G node. Pointing the top of the gateway directly towards a 5G node or tower gives you the strongest signal for mmW deployments.



DIN Rail Mount Bracket

If you are installing in a cabinet or enclosure, use a DIN rail bracket.



Identifying a Location

Use the Inseego Mobile App to identify the optimal location for your S2000e.

1. Scan the QR code to install the Inseego Mobile App from AppStore or Google Play, or visit <https://inseego.com/inseego-connect-get-app> to download the App.



2. Follow instructions within the Inseego Mobile App to connect to your S2000e and perform a location survey to identify the ideal location for your S2000e. **NOTE:** You can use the App for optimal antenna orientation as well.

Connecting Antennas

Finger tighten the appropriate antennas for your desired configuration. Check the label on each antenna to ensure correct placement. **NOTE:** See Chapter 4, Accessories for antenna options available from your Inseego Representative.

NOTE: Recommended torque is 5 in-lbs (56 N-cm).

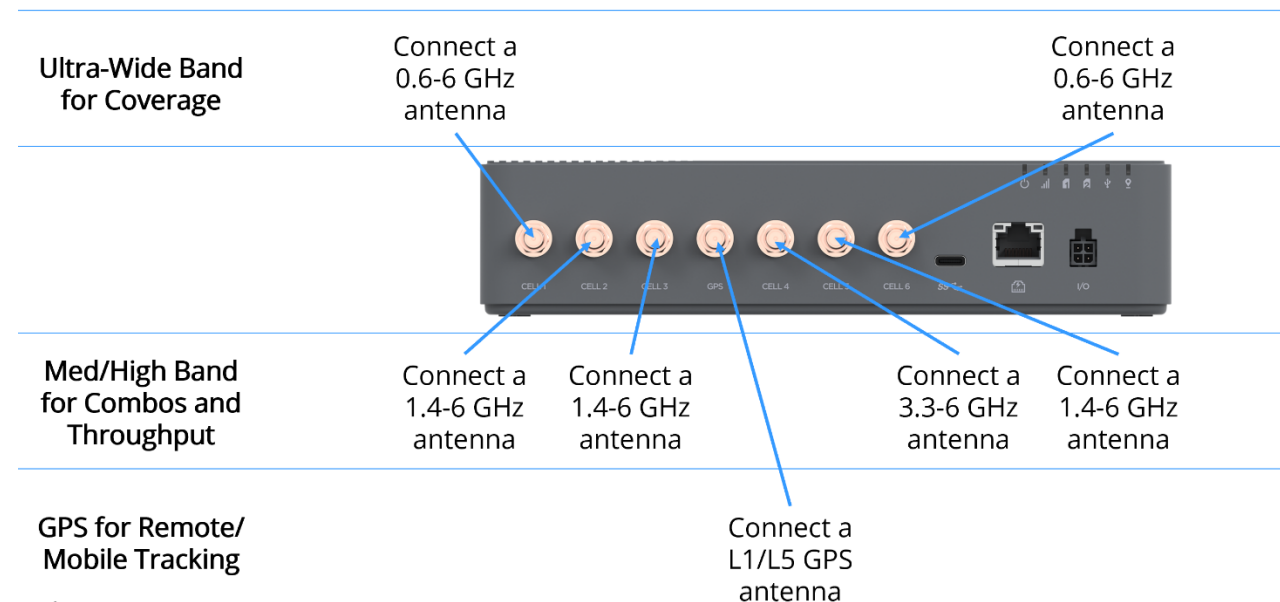

NOTE: The frequencies shown here are provided to optimize your antenna selection. Alternatively, 0.6-6 GHz antennas can be used on all cellular ports. Contact Inseego to discuss available antenna options.

Power Options

Your S2000e has four power options:

- 4-pin AC (50 or 60 Hz), included in box
- 4-pin DC (9-28 VDC), included in box
- PoE+ Injector (60W), sold separately
- USB Power Delivery (15W Min), requires 15W from USB PD host

NOTE: See Chapter 4, Accessories for additional power options.

Connecting 4-Pin DC Power (for Cabinet/Enclosure Installations)

WARNING: Electrical installations can be hazardous and should be performed only by licensed professionals.

Consider the following when installing your S2000e with DC power:

- Ensure easy access for connecting cables.
- Ensure minimum bend radius for cables.
- Avoid sharp edges or existing wiring.
- Avoid proximity to high amperages or extreme temperatures.
- Avoid direct exposure to harmful elements such as water and dust.

Installing and Grounding

To install and ground your device:

1. Use a DIN rail to secure the device in place.
2. Ground the device.
3. If you are installing in a high vibration setting, use cable strain relief to reduce the effects of vibration. Install the strain relief to the same surface as the S2000e, within eight inches of the device. This allows the device and cable to vibrate together. Ensure the cable is not pulling on the power connection.

Connecting to a DC Power Source

The DC cable harness includes power and I/O pins.

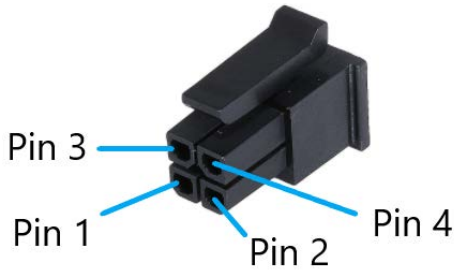

Pin #	DC Power and IO Cable	Color
1	Power	Red
2	Ground	Black
3	GPIO/Ignition Sense	White
4	GPIO	Green

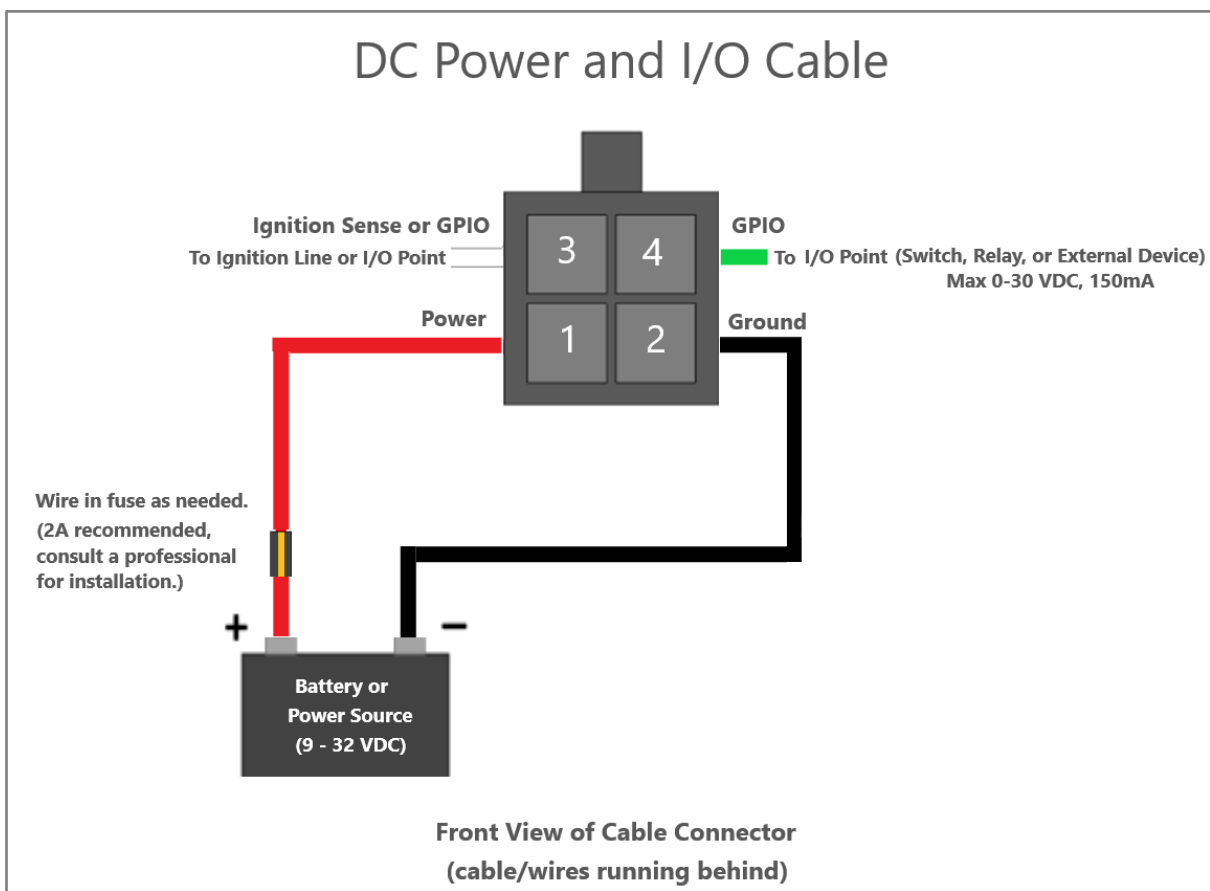

To connect your S2000e to a DC power source:

1. Disconnect the power source, if applicable.
2. Connect the black (ground) wire on the DC power cable to the cabinet, enclosure, or chassis ground.
3. Ensure the S2000e device is also grounded.

4. Fuse the red power wire on the DC power cable to the power source through the fuse box, if appropriate.
5. Connect the power wire on the DC power cable to the power source.
6. If you are using Ignition Sense, connect the white Ignition Sense wire to the ignition line.
NOTE: Ignition Sense ensures a controlled shutdown of the S2000e when the ignition is turned off. You can configure a time delay and/or a voltage level that will trigger the device to shut off. See GPIO Tab on page 40.
7. Connect the DC power cable to the S2000e.
8. Reconnect the power source, if applicable.

Connecting Devices to the Gateway

You can connect to the S2000e gateway with Ethernet, USB, or digital I/O.

Connecting Devices with Ethernet

You can connect to a device via Ethernet.

1. Plug one end of an Ethernet cable into the Ethernet port on the S2000e.
2. Plug the other end of the cable into the Ethernet port of the device you wish to connect.

NOTE: If you are connecting devices via Ethernet using your S2000e as a Dynamic Host Configuration Protocol (DHCP) server on a switch, select **Setting > Advanced > LAN** to view and configure DHCP settings.

Connecting Devices with USB

You can tether to a device with a USB-C port.

1. Connect the USB-C end of a USB cable into the USB-C port on the S2000e. Or, connect a wireless USB-C adapter
2. Connect the USB-A end of a USB cable into the device you wish to connect.

Connecting I/O Devices

You can use the configurable digital GPIO pins to provide on/off data and functionality.

I/O inputs convey information to the S2000e about the state of an external device or system, or can provide Ignition Sense.

I/O outputs are used for the S2000e to tell a device or system to turn on or off.

Monitoring and Managing your Gateway

You can use multiple options to monitor and manage your S2000e.

Inseego Mobile App

You can use the same mobile app you used to find a location for your S2000e to perform basic device monitoring and management.

Admin Web UI

Once your S2000e is connected to a network with a device that supports Web browsing, you can use the Web User Interface to customize settings, change your password, and access information.

On a device connected to the S2000e, open any Web browser and go to <http://192.168.1.1> or <http://inseego.local/> *

Select Sign In (in the top-right corner of the screen), and enter the Admin password printed on the label of the S2000e.

Inseego Connect™

Go to connect.inseego.com to sign up for a free Inseego Connect account, which provides the fullest experience for monitoring and managing S2000e devices from anywhere in the world with access to a web browser.

Common Problems and Solutions

The solutions in this section can help solve many common problems encountered while using the S2000e.

I cannot access the Admin Web UI

- **Reason:** When IP Passthrough (IPPT) is enabled, you need a valid WAN connection to access the Web UI using <http://192.168.1.1>.

Solution: If you are unable to connect to <http://192.168.1.1>, use <http://inseego.local/>.

NOTE: This local address relies on having IPv6 enabled on your connecting device.

My connecting device is not obtaining a valid IP address

There are several possible reasons your connecting device is not obtaining a valid IP address:

* The local Web UI address relies on having IPv6 enabled on your connecting device. See for more information about the local address.

- **Reason:** IPPT is enabled and you do not have a valid WAN connection to obtain an IP address. When IPPT is enabled and there is no WAN connection, no device can obtain the IP address assigned by the mobile network.

Solution: Use <http://inseego.local/> to access the Web UI and disable IPPT or troubleshoot your WAN connection.

- **Reason:** IPPT is enabled and you have connected a second device to your S2000e without restarting. When IP Passthrough (IPPT) is enabled, only the first device detected can obtain the IP address assigned by the mobile network.

Solution: When IPPT is enabled, any time you switch the device you are connecting to the S2000e, you must first disconnect the existing connected device and power cycle the S2000e before connecting the new device.

- **Reason:** The DHCP server has been turned off. If IPPT is not enabled, the DHCP server provides IP addresses. If the DHCP server is turned off, no IP addresses can be provided.

Solutions:

Reset your S2000e to factory settings, see “Resetting your Gateway” on page 18.

or

Use Inseego Connect or Inseego Mobile App LAN settings to turn the DHCP server on.

- **Reason:** The DHCP server has used all of its IP addresses. This is unlikely to happen with the S2000e, but if you have connected a succession of devices to your S2000e in a short period of time, you may have used up all of the IP address available.

Solution: Disconnect your connected device and power cycle the S2000e before reconnecting a device.

- **Reason:** There is an issue with your S2000e.

Solution: Contact your reseller for assistance.

Resetting your Gateway

You can reset your S2000e gateway to factory settings using the RESET button on the device or from the Mobile App, Admin Web UI, or Inseego Connect.

CAUTION! Resetting returns your S2000e to factory settings.

Resetting with the RESET Button

The master reset button is in a small hole located in the SIM compartment on the back of the device. This button returns the device to factory settings, including resetting the admin password.

To reset the S2000e:

1. Remove the SIM cover.
2. Place one end of an unfolded paper clip into the master reset button hole.

To restart the S2000e: Press the paper clip on the button for three to five seconds. The S2000e will restart.

To restore the S2000e to factory default settings: Press and hold the RESET button for over five seconds. This resets all settings to their factory default values.

Resetting from the Inseego Mobile App

To reset the S2000e from the Inseego Mobile App, select **General Settings > Device Options > Factory Reset**.

Resetting from the Admin Web UI

To reset the S2000e from the Admin Web UI, select **Settings > Backup and Restore** and select **Restart Device** to restart the S2000e, or **Restore Factory Defaults** to reset all settings to their factory default values.

Resetting from Inseego Connect

To reset the S2000e from Inseego Connect, on the Devices page, check the box next to the device and select **Factory Reset**.

Technical Support

IMPORTANT: Before contacting Support, be sure to restart both your connected device and your S2000e and ensure that your SIM card is inserted correctly.

Customer Service and Troubleshooting

Contact your reseller for assistance.

More Information

Documentation for your S2000e is available online. Go to www.inseego.com/support-documentation. Or, from the Admin website, select **Support > Customer Support**.

2

Configuration

Overview

Admin Password

Managing Data Usage

Managing Settings

Viewing Info About the Gateway

Getting Support

Overview

You can use multiple tools to configure and troubleshoot your S2000e:

- **Admin Web UI** – Provides a local gateway to configure and manage your S2000e. On a device connected to your S2000e, open any Web browser and go to <http://192.168.1.1> or <http://inseego.local/> *. Select **Sign In** (in the top-right corner of the screen), and enter the **Admin Password**.
- **Inseego Connect** – Enables you to monitor and configure an entire deployment of devices. You can group devices together to push widespread configurations, troubleshoot individual devices, set alarms, and run reports. Go to **connect.inseego.com** to sign up for a free Inseego Connect account.
- **Inseego Mobile App** – Allows you to perform basic device monitoring and management. Scan the QR code to install the Inseego Mobile App from AppStore or Google Play, or visit <https://inseego.com/inseego-connect-get-app> to download the App.



This chapter provides the configuration options available for your S2000e devices. The configurations shown are from the Admin Web UI, unless otherwise noted. Many options are also available with Inseego Mobile App and Inseego Connect. Some configurations are available only with Inseego Connect, and are marked as such.

* The local Web UI address relies on having IPv6 enabled on your connecting device. See for more information about the local address. The address for the Web UI can be configured on the Settings > Advanced > LAN page.

Home Page

The Home page of the Admin Web UI is the local gateway to configuring and managing your S2000e. It displays the SIM status, data usage and provides general status information.

inseeego S2000e LAN USB WAN 5G Sign Out

Home
Data Usage
Settings
About
Support

Welcome To Your S2000e Gateway

Data Usage
SIM 1 (IMSI - 310120265624299, Active)

My Plan: 10.0 GB Data Plan
Data Usage: 8.5 GB remaining

85%
8.5 GB of data remaining
8 days to go

1.5 GB data used 8.5 GB data remaining

All usage is an estimate. Billing cycle ens mm/dd/yyyy.

SIM Status
SIM 1 (IMSI - 310120265624299, Active)

Carrier:	ECGI:	xxxx
ICCID:	RSRP:	xxxx
IMSI:	RSRQ:	xxxx
MDN:	SNR:	xxxx
APN:	PCI:	xxxx

General Status

Model:	S2000e-3
Technology:	LTE
Band:	DC_2A-2A-12A-30A_n66A
WAN Status:	Available
SIM Status:	Connected
FW Version:	xxxx
IPv4:	192.168.1.1
IPv6:	2001:0db8:85a3:0000:0000:8a2e:0370:7334
IMEI:	xxxx
MAC Address:	AA:BB:CC:DD:EE











Side Menu

Each subscreen in the S2000e includes a menu on the left, which you can use to return to the Home page or jump to other pages. The current page is indicated by a blue bar. A similar side menu is available when configuring devices with InseeGo Connect.

- Home
- Data Usage
- Settings
- About
- Support

Header Icons

The top of each S2000e Admin Web UI page displays status indicators and icons.

Header Icon		Description
LAN (Blue)		Routed
LAN (Black)		Available/Online
LAN (Grayed Out)		Disabled/Offline/No Physical Connection
USB (Blue)		Routed
USB (Black)		Available/Online
USB (Grayed Out)		Disabled/Offline/No Physical Connection
Network Signal Strength		Network Signal Strength Indicator. More bars indicate more signal strength.
SIM (Blue)		Routed
SIM (Black with Checkmark)		Available/Online
SIM (Grayed Out)		Disabled/Offline/No SIM

Getting Help

Select the question mark (?) in the upper right hand corner of a page to view Help on that topic.

Admin Password

The Admin password is what you use to sign into the S2000e. A default Admin password is assigned to each individual device and is printed on the label of the device. You are prompted to change the Admin password after the first login. Change it to something easier to remember and set up a security question that will help you securely recover your password if you forget what you changed it to.

Important: It is critical that you change the Admin password from the default to keep the device and your network secure.

Changing the Admin Password

To change the Admin password:

1. **From the Admin Web UI:** Click the down arrow next to **Sign Out** in the top-right corner of any Admin Web UI page and select **Change Password**.

From Inseego Connect: Select **Device > Admin Password** from the Configure side menu.

2. Enter your current Admin password, then enter a new password and confirm it.
3. Select a security question from the drop-down list and type an answer to question in the **Answer** field.
NOTE: Answers are case-sensitive.
4. Click **Save Changes**.

The next time you sign in to the S2000e, use the new Admin password. If you cannot remember the password, click **I forgot the Admin password**. After you correctly answer the security question you set up, the current password is displayed.

Managing Data Usage

You can monitor and manage data usage on your S2000e using the Data Usage page.

On the Admin Web UI Home page, the Data Usage panel shows current data usage information.

The screenshot shows the Admin Web UI for the inseeego S2000e. The top navigation bar includes the logo, device name, connection icons (LAN, USB WAN, Wi-Fi, 5G), and a 'Sign Out' button. The main content area is divided into three sections:

- Home:** A navigation menu with links for Home, Data Usage, Settings, About, and Support.
- Welcome To Your S2000e Gateway:** A central message with an image of the gateway device.
- Data Usage:** A panel highlighted with a red box, showing data usage for SIM 1 (IMSI - 310120265624299, Active). It includes a circular progress indicator at 85% (8.5 GB remaining), a bar chart showing 1.5 GB data used and 8.5 GB data remaining, and a timer for 8 days to go. A right-pointing arrow is visible at the bottom right of this panel.
- SIM Status:** A table showing SIM 1 details: Carrier, ICCID, IMSI, MDN, APN, ECGI, RSRP, RSRQ, SNR, and PCI.
- General Status:** A table showing device details: Model, Technology, Band, WAN Status, SIM Status, FW Version, IPv4, IPv6, IMEI, and MAC Address.

To manage or view data usage, select **>** from the Home page Data Usage panel or select **Data Usage** from the side menu. The Data Usage page appears.

Data Usage Page

Use the Data Usage page to view details and manage your S2000e data usage.

The screenshot shows the 'Data Usage' page for the insee-go S2000e device. The page is divided into a sidebar and a main content area. The sidebar contains links for Home, Data Usage, Settings, About, and Support. The main content area is titled 'Data Usage' and features a dropdown menu for 'SIM information being displayed' set to 'SIM 1 IMSI (Active)'. A large circular progress indicator shows '85%' remaining, with '8.5 GB of data remaining' and '8 days to go'. Below this, a bar chart shows '1.5 GB data used' and '8.5 GB data remaining'. A 'Reset data counter now' button is present. Further down, there are settings for 'Reset data counter on this day of the month' (10) and 'Maximum data limit' (10 GB). A table displays session and monthly statistics.

Session Start:	.	DD / HH:MM:SS
Session Duration:		HH:MM:SS
Session Tx:		1.5 GB
Session Rx:		1.5 GB
Monthly Tx:		0.5 GB
Monthly Rx:		0.75 GB
Monthly Total:		1.5 GB

SIM information being displayed: Use the drop-down to change the SIM on which data usage is displayed.

The data usage graph displays vary according to plan, but generally include:

- Estimated percentage of data remaining for the current billing cycle
- Number of days left in the billing cycle
- Data limit on your plan
- Estimated amount of data used in the current billing cycle
- Estimated amount of data remaining for the current billing cycle
- Date the billing cycle ends

Use the **Reset data counter now** button to restart the data usage shown on this page to zero.

Reset data counter on this day of the month: Use the drop-down to select a day of the month for the counter displayed on this page to reset.

Maximum data limit: Enter a maximum data limit, if desired.

Session Start: The date and time the current Internet session began.

Session Duration: The amount of time that has elapsed since the connection for the current Internet session was established.

Session Tx: The amount of data transmitted for the current Internet session. This counter starts at zero when the connection is established.

Session Rx: The amount of data received for the current Internet session. This counter starts at zero when the connection is established.

Monthly Tx: The amount of data transmitted for the current billing cycle.

Monthly Rx: The amount of data received for the current billing cycle.

Monthly Total: The total amount of data for the current billing cycle.

Select **Save Changes** to enact changes.

Managing Settings

To view and configure settings for your S2000e, select **Settings** from the side menu.

The Settings page includes the following tabs:

- Preferences
- Software Update
- Backup and Restore
- GPS
- VPN
- GPIO
- Advanced

Preferences Tab

This tab allows you to change how dates, time, distance, and numbers are displayed, and what language is used, in the S2000e Web UI. **NOTE:** These preferences affect packets sent to remote servers. For example, if you select a 24 hour time format, the Web UI, and any packets reporting time somewhere else, will display time in 24 hour format.

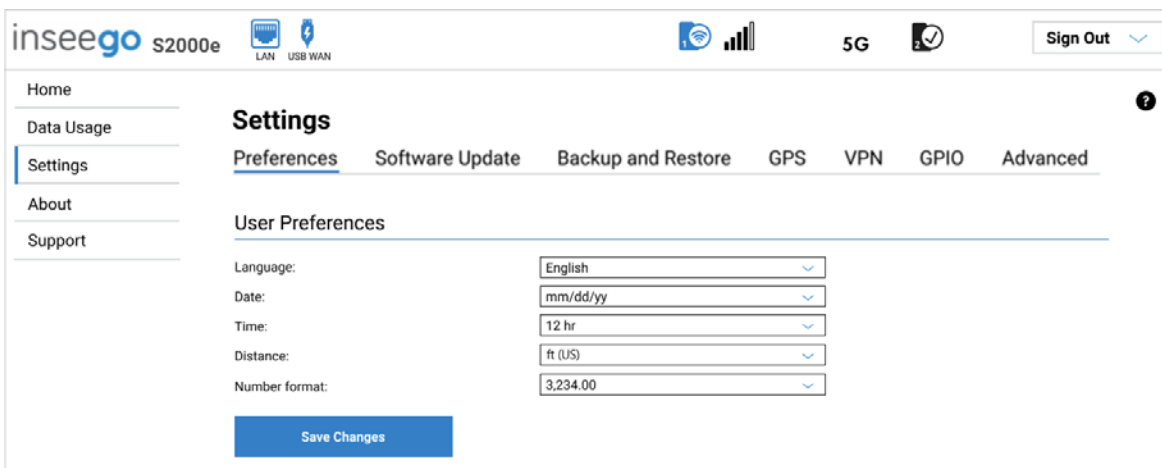

User Preferences

Language: Select a language for the Web UI.

Date: Select the format for dates displayed in the Web UI (mm/dd/yyyy or dd/mm/yyyy).

Time: Select the format for time displayed in the Web UI (12 or 24 hour).

Distance: Select the format for distance displayed in the Web UI (feet or meters).

Number format: Choose the format for decimal numbers displayed in the Web UI (using a period or comma as the decimal point).

Select your display choices from the drop-down menus and click **Save Changes** to update settings.

Software Update Tab

Software updates are delivered to the S2000e automatically over the mobile network. This tab displays your current software version, last system update information, software update history, allows you to check for new software updates, and to opt-out of automatic software updates.

The screenshot shows the 'inseeego S2000e' interface. At the top, there are icons for LAN, USB WAN, 5G, and a 'Sign Out' button. A left sidebar contains 'Home', 'Data Usage', 'Settings', 'About', and 'Support'. The main content area is titled 'Settings' and has sub-tabs for 'Preferences', 'Software Update', 'Backup and Restore', 'GPS', 'VPN', 'GPIO', and 'Advanced'. The 'Software Update' sub-tab is active. It contains sections for 'Current Software' (showing version 1W and details), 'Automatic Software Updates' (with an 'ON' toggle), 'Check for Software Update' (showing last check on 8/12/2020 and 'No update available'), 'Last Software Update' (showing 'No updates applied'), and 'Software Update History'.

Current Software

Software Version: The version of the software currently installed on your S2000e.

Automatic Software Updates

By default, software updates are automatically delivered to your S2000e. This setting allows you to opt-out of automatic software updates. If you do not want software updates automatically delivered, move the **ON/OFF** slider to **OFF**.

Check for Software Update

Last Check for Update: The date and time the S2000e last checked to see if an update was available.

Update Status: This area is usually blank. If you check for an update, the results display.

Check for Update: Click this button to manually check for available software updates. If a new software update is available, it is automatically downloaded.

Last Software Update

This section displays details about the last software update.

Software Update History

This section displays details of the last updates that have been downloaded and installed to this device. If no updates have been installed, this section is not displayed.

Backup and Restore Tab

Use this tab to back up current S2000e settings to a file on your computer, restore (upload) a previously-saved configuration file, reset the S2000e to factory defaults, or restart it.

The screenshot shows the Admin Web UI for the inseeego S2000e device. The top navigation bar includes the device name, connection status (LAN, USB WAN), signal strength, 5G connectivity, and a 'Sign Out' button. The left sidebar contains links for Home, Data Usage, Settings (selected), About, and Support. The main content area is titled 'Settings' and has sub-tabs for Preferences, Software Update, Backup and Restore (selected), GPS, VPN, GPIO, and Advanced. The 'Backup Configurations' section includes a 'Download' button and a note about the backup file. The 'Restore Settings' section includes an 'Admin password' field, a 'Note' about lockouts, a file selection area with a 'Browse' button, and a 'Restore Now' button. The 'Restore to Factory Defaults' section includes a 'Restore Factory Defaults' button. The 'Restart S2000e-3' section includes a 'Restart' button.

Backup Configurations

To back up current S2000e settings to a file on your computer, enter your Admin password in the **Admin password** field.

The default Admin password is printed on the label of the S2000e. If you have changed the Admin password and don't remember it, select **Sign In** in the top-right corner of the Home page, click **I forgot the Admin password**, and answer the displayed security question. The current Admin password will be displayed.

NOTE: If you enter an incorrect password five times in a row, you will be locked out of the Admin Web UI. To unlock it, restart your S2000e.

Click the **Download** button. The file is automatically downloaded to the default Downloads folder on the device connected to the Admin Web UI. This configuration file contains all settings for your S2000e.

NOTE: The backup file cannot be edited or viewed on the downloaded system or on any other device. This file can only be restored for this model and firmware version of S2000e, and settings can only be viewed or changed using the Admin Web UI.

Restore Settings

CAUTION! Restoring settings (uploading a configuration file) changes ALL of the existing settings to match the configuration file.

To restore system settings from a backup settings file, click **Browse** and choose a backup settings file to restore.

Enter your Admin password in the **Admin password** field.

NOTE: You can only restore a file that was created for this model of S2000e.

Click the **Restore Now** button.

Restore to Factory Defaults

Restore Factory Defaults: This button resets all settings to their factory default values.

CAUTION! This initiates a restart and resets all settings to factory default values.

Restart S2000e-3

Restart: This button turns your S2000e off and on again.

GPS Tab

The S2000e incorporates a GPS receiver. The GPS receiver can determine your current location. Current location information can be shared with connected devices by using the Local GPS Streaming Interface on the Local tab.

The GPS page includes three sub tabs:

- GPS Status
- GPS Local
- GPS Remote

GPS Status Sub Tab

Use settings on this tab to enable or disable GPS and to view current location and the current status of your GPS connection.

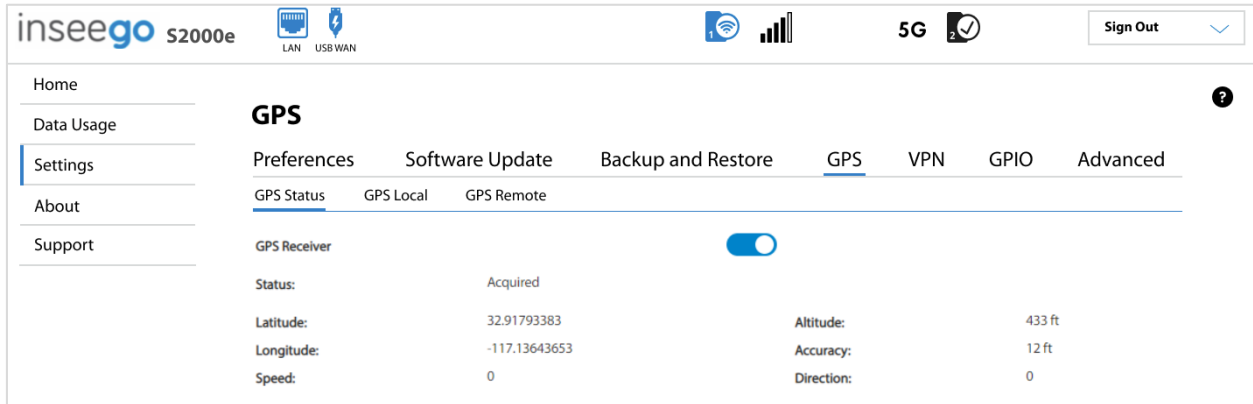

GPS Receiver: This setting enables or disables the GPS radio on your S2000e. When the **ON/OFF** slider is **ON**, the device acquires GPS and makes GPS location data available on this page. A GPS Agreement appears, click **Confirm** to proceed. When **OFF**, no GPS data is available.

Status: The current status of your GPS connection. When searching, the device is making the connection to satellites in order to populate GPS data.

Latitude: Latitude for the last location fix.

Longitude: Longitude for the last location fix.

Speed: Speed the device is traveling at.

Altitude: Altitude for the last location fix.

Accuracy: A measure of the accuracy of the horizontal position obtained by the GPS receiver.

Direction: Direction the device is traveling relative to North.

GPS Local Sub Tab

Use this tab to enable GPS streaming to client devices on the local network. Raw GPS data is provided by the S2000e in the form of a National Marine Electronics Association (NMEA) text stream. You can use third-party applications to utilize or forward the GPS data to a remote server.

The screenshot shows the 'insee-go S2000e' web interface. The top navigation bar includes 'Home', 'Data Usage', 'Settings', 'About', and 'Support'. The main content area is titled 'GPS' and has sub-tabs for 'Preferences', 'Software Update', 'Backup and Restore', 'GPS', 'GPIO', and 'Advanced'. Under the 'GPS' tab, there are sub-sections for 'GPS Status', 'GPS Local', and 'GPS Remote'. The 'GPS Local' section is active and contains the following settings:

- Turn on Local GPS:** A toggle switch is turned on.
- Global Device/TAIP ID:** A text input field containing '1234'.
- Network Protocol:** A dropdown menu set to 'TCP'.
- Store and Forward:** An unchecked checkbox.
- Port number:** A text input field containing '11010', with a note '1024-65535 For TCP connections'.
- Virtual port driver:** A note stating 'A windows driver is available to connect to the NMEA stream above and create a virtual NMEA port. [Download GPS driver](#)'.
- Active Sentences:** A section titled 'NMEA (IDENT, GGA, RMC)' with a list of checkboxes:
 - IDENT - Vehicle ID
 - GGA - Global Positioning System Fix data
 - GLL - Geographic position
 - GSA - GPS DOP & Active Satellites
 - GSV - GPS Satellites in view
 - RMC - Rec. minimum specific GPS/Transmit data
 - VTG - Track mode good & ground speed
 - ZDA - Date/Time
- GPS reporting mode:** Radio buttons for 'NMEA' (selected) and 'TAIP'.
- Reporting Triggers:** A section with three rows:
 - Reporting Time Interval:** 300 seconds (valid range: 5 – 3600)
 - Reporting Distance Interval:** 1000 feet (valid range: 130 – 215009)
 - Report if stationary for:** 900 seconds (valid range: 5 – 46800)

A 'Save Changes' button is located at the bottom of the settings area.

Turn on Local GPS: Check this box to turn on GPS streaming on the local network.

Global Device/TAIP ID: You can enter a 4-digit ID that is inserted into your GPS packet for routing to servers, identifying your S2000e. If left blank, the ID is left off the local broadcast.

Network Protocol: Select the protocol to use for local GPS streaming from the drop-down (**TCP** or **UDP**).

- **Store and Forward:** If there is an interruption in the WAN interface, the system can store packets and forward them once the WAN interface connection returns. If you select **TCP** as the Network Protocol, you can check the Store and Forward box if you want the system to store and forward packets.
- **IP Address:** If you select **UDP** as the Network Protocol, the IP Address field appears.

Port number: The port number used by the software on your computer to establish a connection to your S2000e and obtain GPS data. Unless there is a good reason to do so, you should not change the port number.

Virtual port driver: If you want to access the GPS data stream from a virtual COM port instead of the port (above), click the **Download GPS driver** link to download and install a GPS driver for your Windows platform. This driver creates a virtual NMEA port, obtains GPS data from the S2000e, and makes this GPS data available to NMEA-aware third-party applications.

GPS reporting mode: The S2000e is capable of routing NMEA or TAIP sentences to the local server. Select **NMEA** or **TAIP**. The available options for your selection are displayed in **Active Sentences**. Select or de-select any option. All options that are checked will be part of the packet routed to the local server.

Reporting Triggers

Reporting Time Interval: You can set a time interval, in seconds, for reporting frequency. For example, if you select 900, a GPS packet is sent every 15 minutes. Check the box if you want to use the time interval.

Reporting Distance Interval: You can set a distance interval to trigger when packets will be routed to the server. For example, if you select 1000, a GPS packet will be sent to the server every time your device moves 1000 feet. Check the box if you want to use the distance interval.

NOTE: If you set both a time and distance interval, the device routes packets based on which event occurs first.

Report if stationary for: You can set a stationary timer that monitors for movement and only routes packets if the S2000e is continuously moving within the time range (in seconds). For example, if you set this value to 300 and your device has not moved within 5 minutes, a packet will not be routed until the 300 seconds is exceeded. Once your device begins registering GPS movement again, packet routing will resume. Check the box if you want to use the stationary timer.

Click **Save Changes** to update settings.

GPS Remote Sub Tab

Use this tab to configure the system to stream GPS data to remote servers. **NOTE:** These servers are not Inseego Connect. Use **Settings > Advanced > Inseego Connect** to enable Inseego Connect remote servers.

The screenshot shows the Inseego S2000e web interface. The top navigation bar includes the Inseego logo, device model 'S2000e', connection status (LAN, USB WAN), signal strength, 5G connectivity, and a 'Sign Out' button. The main content area is titled 'Settings' and has sub-tabs for Preferences, Software Update, Backup and Restore, **GPS**, VPN, GPIO, and Advanced. Under the 'GPS' tab, there are sub-sections for 'GPS Status', 'GPS Local', and 'GPS Remote'. The 'GPS Remote' section contains a toggle for 'Turn on Remote GPS' (which is turned on), a text input for 'Global Device / TAIP ID' with the value '1234', and a 'Save Changes' button. Below this is a table titled 'GPS Remote Server Configurations' with columns for 'Server Name', 'Server Address', and 'Reporting'. The table lists three servers: 'Test' (192.168.1.10), 'Test 1' (192.168.1.11), and 'Test 2' (192.168.1.12), all with 'Reporting' set to 'Yes'. Each row has 'Edit' and 'Delete' buttons. At the bottom of the table is an 'Add Remote Server' button.

Turn on Remote GPS: Check this box to turn on GPS streaming to remote servers.

Global Device/TAIP ID: A 4-digit ID identifying your S2000e that is inserted into your GPS packet for routing to remote servers. By default this is 1234.

Click **Save Changes**.

GPS Remote Server Configurations

Add Remote Server: Use this button to add a remote server. The **Add new server details** dialog appears.

The dialog box titled 'Add new server details' contains the following fields and options:

- Server Name:** Text input field.
- Reporting:**
- Store & Forward:** If the server is not available, store data until it is, then send it
- Server Address:** Text input field with value '192.168.1.100'
- Port Number:** Text input field with value '1234'
- Network Protocol:** Dropdown menu with 'TCP' selected.
- Active Sentences:** [Active Sentences](#) (link) and 'NMEA (GGA, RMC, IDENT)' (text).
- Reporting Triggers:**
 - Reporting Time Interval:** seconds (5 ~ 3600)
 - Reporting Distance Interval:** feet (130 ~ 215009)
 - Report if stationary for:** seconds (5 ~ 46800)

Buttons: 'Cancel' and 'Save Changes'.

- **Server Name** — Enter a name for the GPS remote server.
- **Reporting** — To begin streaming GPS data from your S2000e to this remote server, check this box.
- **Store & Forward** — If there is an interruption in the WAN interface, the system can store packets and forward them once the WAN interface connection returns. Check this box if you want the system to store and forward packets.
- **Server Address** — Enter the address for the remote server to which you would like to route packets.
- **Port Number** — Enter the port for the remote server to which you would like to route packets. Acceptable port values are between 1024 and 65535.
- **Network Protocol** — Select the protocol to use for routing packets to your remote server from the drop-down (TCP or UDP).
- **Active Sentences** — The S2000e is capable of routing NMEA or TAIP sentences to remote servers. Click the link to select NMEA or TAIP and the available options. All options that are selected will be part of the packet routed to the remote server.

Reporting Triggers

- **Reporting Time interval** — You can set a time interval to trigger when packets will be routed to the remote server. For example, if you select 900 seconds, a GPS packet will be sent to the remote server every 15 minutes.
- **Reporting Distance interval** — You can set a distance interval to trigger when packets will be routed to the remote server. For example, if you select 1000 feet, a GPS packet will be sent to the remote server every time your device moves 1000 feet.
NOTE: You can choose both Time and Distance as your interval specification. The device will route packets based on which event occurs first.
- **Report if stationary for** — You can set a stationary timer that monitors for movement and only route packets if the device is continuously moving within the time range. For example, if you set this value to 60 seconds and the device has not moved within 60 seconds, a packet will not be routed until 60 seconds is exceeded. Once your device begins registering GPS movement again, packet routing will resume. **NOTE:** The stationary timer minimum is constrained by the Reporting Time Interval. You cannot have a stationary timer value that is less than the Reporting Time Interval.

Click **Save** to implement your settings or **Cancel** to cancel. You return to the Remote page. The new remote server is now listed under GPS Remote Server Configurations.

Use the **View**, **Edit**, and **Delete** buttons to view, edit, or delete listed remote servers.

VPN Tab

You can configure and enable OpenVPN with your S2000e. If OpenVPN is connected, there is no need for devices connected to the gateway to use their own OpenVPN client.

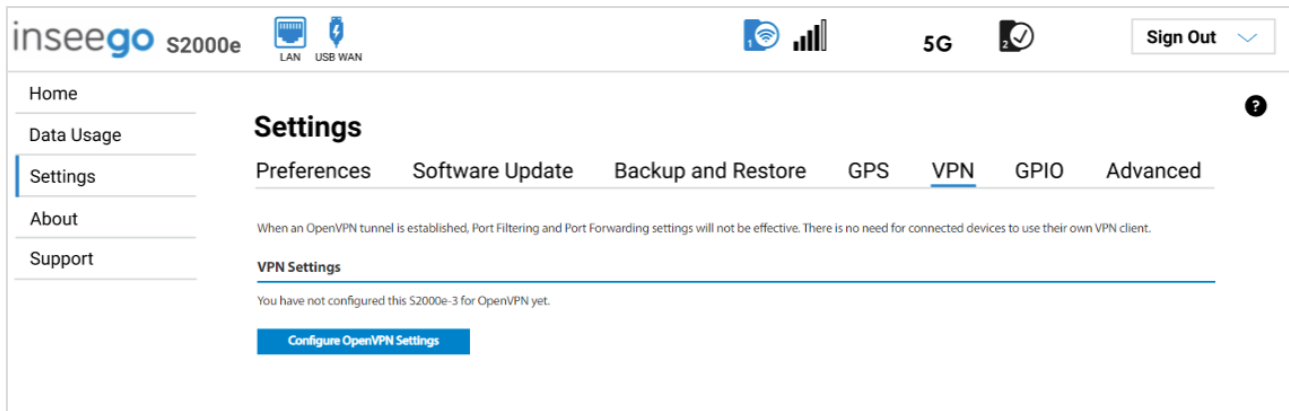

Click **Configure OpenVPN Settings** to configure an OpenVPN connection. The Configure OpenVPN Settings dialog appears.

The dialog box is titled 'Configure OpenVPN Settings' with a close button (X) in the top right. It contains the following fields and controls:

- 'OpenVPN Configuration Files:' with a grey box containing the text 'Drag and drop files from your OpenVPN provider here.'
- 'Username:' with a text input field.
- 'Password:' with a text input field and an eye icon for toggling visibility.
- 'Auto-Connect VPN' with a toggle switch and an information icon (i).
- At the bottom, there are two buttons: 'Clear all OpenVPN Settings' (white with blue border) and 'Save Changes and Connect' (blue).

OpenVPN Configuration Files: Drag and drop files from your OpenVPN provider in the box.

Username: Enter a username.

Password: Enter a password. **NOTE:** You can click the eye icon to view the password.

Auto-Connect VPN: Use the **ON/OFF** slider to enable or disable auto-connect for the OpenVPN connection.

Use the **Clear all OpenVPN Settings** or **Save Changes and Connect** buttons to clear or save your settings.

The configured OpenVPN appears on the VPN Tab with the following information.

VPN Connection

Connection Status: Indicates the status of the OpenVPN connection.

Connection Time: The duration of the current OpenVPN connection.

Edit VPN Settings: Use this button to open the Configure OpenVPN Settings dialog and edit settings.

View Logs: Use this button to view OpenVPN log files.

Connect: Use this button to connect the OpenVPN.

GPIO Tab

The S2000e includes configurable digital General Purpose Input Output (GPIO) pins for external system monitoring or control. Use settings on this tab to enable or disable pins and view or configure pin settings.

The screenshot shows the inseeego S2000e web interface. The top navigation bar includes the logo, device name, LAN/USB WAN status, signal strength, 5G connectivity, and a 'Sign Out' button. The left sidebar contains links for Home, Data Usage, Settings (selected), About, and Support. The main content area is titled 'Settings' and has sub-tabs for Preferences, Software Update, Backup and Restore, GPS, VPN, GPIO (selected), and Advanced. The 'GPIO' sub-tab is active, showing the '4 Pin Power and I/O Connector' section. A diagram of a 4-pin connector is shown with pins numbered 1, 2, 3, and 4. To the right of the diagram, the pin functions are listed: Pin 1 - V in, Pin 2 - Ground, Pin 3 - Digital I/O, and Pin 4 - Digital I/O. Below the diagram, the 'Pin 3 - Ignition Sense or Digital I/O' section is expanded, showing configuration options for 'Ignition Sense or Digital I/O Setting' (set to 'Enable Ignition Sense'), 'Ignition Sense Options' (set to 'Ignition Time-Voltage Based Shutdown'), 'Shut down after' (set to 8 minutes), and 'Shut down when external battery reaches' (set to 8 V). A 'Save Changes' button is located below these settings. The 'Pin 4 - Digital I/O' section is also visible, with options for 'Digital I/O Setting' (set to 'Enable'), 'I/O Setting' (set to 'Input'), 'I/O Setting Name', 'Low State Name', 'High State Name', 'Current State' (set to 'Low/High'), and 'Create Banner Alert in UI' (set to 'None'). A 'Save Changes' button is also present at the bottom of this section.

4 Pin Power and I/O Connector

The S2000e power port includes voltage in, ground, and two digital I/O pins.

NOTE: The diagram shows the pins from the front of the cable connector (with the wires running behind).

Pin 3 – Ignition Sense or Digital I/O

Ignition Sense or Digital I/O Setting: Use the drop-down to select **Enable Ignition Sense** or **Enable Digital I/O**.

If you select **Enable Ignition Sense**:

Ignition Sense Options: Select an option from the drop-down:

- **Ignition Time-Voltage Based Shutdown** – Allows you to specify an amount of time and battery level. When the ignition is turned off, the device stays on until one of the thresholds is met, at which point it shuts down.
- **Ignition Time Based Shutdown** – Allows you to specify the amount of time you want the S2000e to remain on after the ignition is turned off.
- **Ignition Voltage Based Shutdown - Voltage Level:** Allows you to specify the battery level at which you want the S2000e to turn off.

Shut down after: Enter the number of minutes you want the S2000e to stay on after the ignition is turned off.

Shut down when external battery reaches: Enter the number of volts to use as a battery level threshold. When the battery reaches that amount of voltage, the S2000e will shut down.

If you select **Enable Digital I/O**:

Input Setting: Select **Input** or **Output**.

NOTE: Input can be Input, used to tell the S2000e the state of an external device or system. Output is used to turn another device or system on (low) or off.

I/O Setting Name: Enter a user-friendly name for the setting.

Low State Name: Enter a user-friendly name for the low state.

High State Name: Enter a user-friendly name for the high state.

Current State: The current state of the pin: low or high.

Create Banner Alert in UI: Select an option for state change alerting in Inseego Connect.

Pin 4 – Digital I/O

Digital I/O Setting: Use the drop-down to enable or disable Pin 4.

Digital I/O options are the same as for Pin 3.

Advanced Tab

Advanced settings are intended only for users with advanced technical knowledge. For information about the Advanced Settings page, go to Chapter 4, Advanced Settings on page 51.

Viewing Info About the Gateway

The General Status panel on the Web UI Home page shows connection and general status information.

Model: The model of the device.

Technology: Indicates the current cellular data connection, for example, 5G Sub6.

Band: The band combination, anchor band, or bandwidth in use for the current connection.

WAN Status: The current status of the WAN connection.

SIM Status: The current status of the SIM card.

FW Version: The version of the firmware (software) currently installed on your S2000e.

IPv4: The network IP address of the S2000e.

IPv6: The Local-Link IPv6 address of the S2000e.

IMEI: The International Mobile Equipment Identity (IMEI) for your S2000e. This is a 15 digit code used to uniquely identify an individual mobile station. The IMEI does not change when the SIM is changed.

MAC Address: The Media Access Controller (MAC) Address for your S2000e. The MAC address is a unique network identifier assigned when a network device is manufactured.

To view more detailed information about your S2000e and its use, select **About** from the Web UI side menu.

The About page includes the following tabs:

- Internet Status
- Internet Sessions
- Diagnostics
- Device Info
- Logs

Internet Status Tab

Use the Internet Status tab to view general Internet connection and system information.

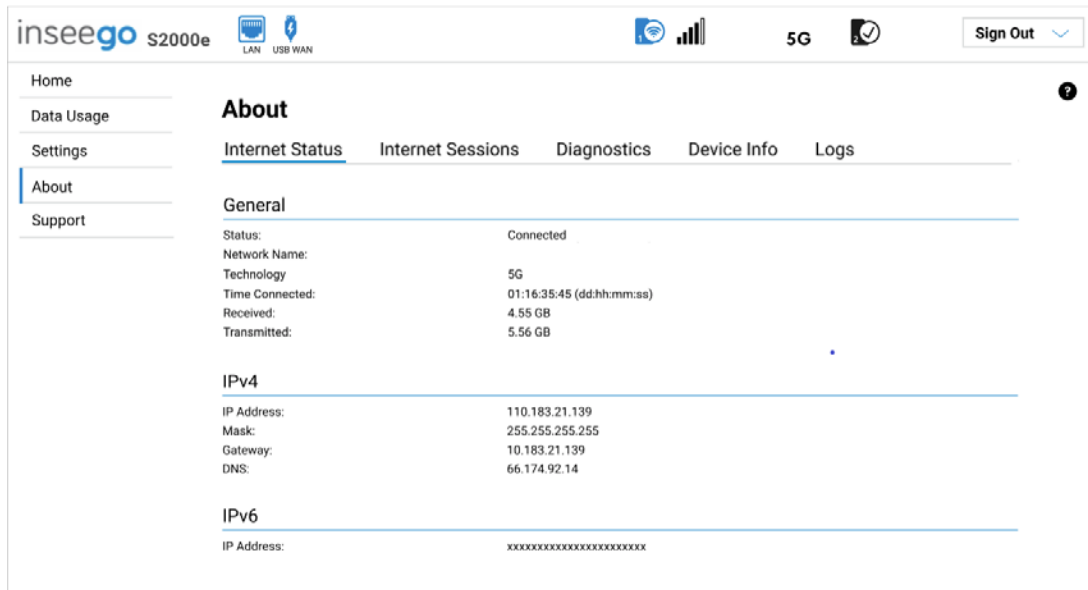

General

Status: The current status of the S2000e connection.

Network Name: The name of the network for the current Internet session established.

Technology: Indicates the current cellular data connection, for example, 5G.

Time Connected: The amount of time that has elapsed since the connection for the current Internet session was established.

Received: The amount of data received for the current Internet session. This counter starts at zero when the connection is established.

Transmitted: The amount of data transmitted for the current Internet session. This counter starts at zero when the connection is established.

IPv4

IP Address: The Internet IP address assigned to the S2000e.

Mask: The network mask associated with the IPv4 address.

Gateway: The gateway IP address associated with the IPv4 address.

DNS: The Domain Name Server currently used by the S2000e.

IPv6

IP Address: The global IPv6 address for the S2000e (blank if IPv6 is turned off or is not supported by the current network connection or operator).

Internet Sessions Tab

Use the Internet Sessions tab to export and view Internet session data.

Date/Time	Duration	Received Data	Transmitted Data	Total Data	IPv4 Address	IPv6 Address
01/04/2020 8:39:48 PM	03:00:48:23	394.18 MB	28.51 MB	452.69 MB	173.114.192.255	2600:1:b068:e1:c51e:cc1:a21a:b489

Export Internet Sessions Information

Click the **Export** button to export Internet session data.

Internet Sessions

NOTE: Internet Sessions are presented in date order.

Date/Time: The date and time the Internet session began.

Duration: The total amount of time for the Internet session.

Received Data: The amount of data received for the Internet session. This counter starts at zero when the connection is established.

Transmitted Data: The amount of data transmitted for the Internet session. This counter starts at zero when the connection is established.

Total Data: The total amount of data for the Internet session. This is the sum of Received Data and Transmitted Data.

IPv4 Address: The IP address for the session.

IPv6 Address: The global IPv6 address for the session (blank if IPv6 is turned off or is not supported by the current network connection or carrier).

Diagnostics Tab

This tab displays detailed information used solely for troubleshooting or technical support.

The screenshot shows the inseeGO S2000e web interface. The top navigation bar includes the logo, device name, connection icons (LAN, USB WAN), signal strength, 5G indicator, and a 'Sign Out' button. The left sidebar contains a menu with 'Home', 'Data Usage', 'Settings', 'About', and 'Support'. The main content area is titled 'About' and has sub-tabs for 'Internet Status', 'Internet Sessions', 'Diagnostics' (selected), 'Device Info', and 'Logs'. The 'Diagnostics' tab is active, showing two sections: 'Modem' and '4G LTE Network'. The 'Modem' section lists: Mobile Number (MDN): 858.336.5349, IMEI: 9900 1664 0007 157, IMSI: 310410210707294, and FW Version: SDX55MOR-2.52.1 [2021-09-26 23:59:06]. The '4G LTE Network' section lists: Status: Connected, Technology: 4G LTE, Band: B2A, Network Operator: AT&T, Signal Strength (RSRP): -104 dBm, SNR: 8 dB, Roaming: No, and Cell ID(ECGI): 862296370121059.

Modem

Mobile Number (MDN): The phone number of your S2000e.

IMEI: The International Mobile Equipment Identity (IMEI) for your S2000e. This is a 15 digit code used to uniquely identify an individual mobile station. The IMEI does not change when the SIM is changed.

IMSI: The International Mobile Subscriber Identity (IMSI) for your S2000e. This is a unique number, usually fifteen digits, that identifies a Global System for Mobile Communications (GSM) subscriber.

FW Version: The version of the firmware (software) currently installed on your S2000e.

Network

Status: The status of the network.

Technology: Indicates the current cellular data connection, for example, 5G Sub6.

Band: The band in use for the current connection.

Network Operator: The name of the Mobile Network Operator (MNO).

Signal Strength (RSRP): The strength of the cellular signal, measured in dBm. Higher absolute values indicate a stronger signal, for example: -80 dBm is a stronger signal than -90 dBm.

SNR: Signal to Noise Ratio. A ratio of signal power to noise power expressed in decibels. SNR is a positive value, and higher numbers are better.

Roaming: Indicates whether roaming is on.

Cell ID(ECGI): The ECGI code used to identify cells globally.

Device Info Tab

Use this tab to view details about your S2000e.

The screenshot shows the Inseego S2000e web interface. At the top, there is a header with the Inseego logo, 'S2000e', and connection status icons for LAN, USB WAN, Wi-Fi, cellular signal, and 5G. A 'Sign Out' button is in the top right. A left sidebar contains navigation links: Home, Data Usage, Settings, About (selected), and Support. The main content area is titled 'About' and has sub-tabs: Internet Status, Internet Sessions, Diagnostics, Device Info (selected), and Logs. Under 'Device Info', there are two sections: 'General' and 'Software Components'. The 'General' section contains a table with device details, and the 'Software Components' section contains a table with version information.

General	
Manufacturer:	Inseego
Model:	S2000e-1
Device Version:	1.02
SKU:	xxxx

Software Components	
OS Version:	xxxx
Modem Firmware Version:	xxxx
Web UI Version:	xxxx
PRI Version:	xxxx

General

Manufacturer: Inseego.

Model: Model of the device.

Device Version: The version of firmware (software) currently installed.

SKU: The SKU for your S2000e.

Software Components

OS Version: The version number for the Operating System and its components.

Modem Firmware Version: The version of firmware (software) currently installed for the modem component.

Web UI Version: The version number for the S2000e Admin Web UI.

PRI Version: The configuration version currently applied to the S2000e.

Logs Tab

Use this tab to view log information for troubleshooting.

The screenshot shows the 'inseeego S2000e' web interface. The top navigation bar includes 'LAN', 'USB WAN', '5G', and a 'Sign Out' button. The left sidebar contains a menu with 'Home', 'Data Usage', 'Settings', 'About', and 'Support'. The main content area is titled 'About' and 'Log Settings'. Under 'Log Settings', there is a checkbox for 'Turn On Logging' which is checked, and a dropdown menu for 'Automatically clear logs' set to 'After 3 days'. A 'Save Changes' button is present. Below this, there are two tabs: 'Mobile Network Log' and 'Device Log'. The 'Mobile Network Log' tab is active, displaying a list of log entries with timestamps and details about network events like IP address acquisition and connection states. At the bottom, there are buttons for 'Refresh', 'Clear Log', and 'Export Logs'.

Log Settings

Turn On Logging: Check this box to turn on logs as needed.

Automatically clear logs: Use the drop-down list to select when logs are cleared. **NOTE:** If the log is full, the oldest data is deleted regardless of this setting.

Click **Save Changes** to enact changes.

If logs are turned on, the following are visible:

Click on **Mobile Network Log** for log data of connections to the mobile network.

Click on **Device Log** for log data of events other than mobile data connections that occurred on this device.

Refresh: Updates the displayed log data.

Clear Log: Deletes all existing log data. This makes new data easier to read.

Export Logs: Allows you to export log data.

Getting Support

For Support, select Support from the Admin Web UI side menu.

Customer Support Tab

Use the Customer Support tab for useful links and support information.

The screenshot shows the Admin Web UI for an inseeego S2000e device. The top navigation bar includes the inseeego logo, model number S2000e, LAN and USB WAN connection icons, 5G signal strength, a battery icon, and a Sign Out button. A left sidebar menu contains links for Home, Data Usage, Settings, About, and Support (which is highlighted). The main content area is titled 'Customer Support' and features a 'Your Device' section with the following information:

Model:	S2000e-3
Your Wireless Number:	858.336.5349
User Guide:	S2000e-3 User Guide
Manufacturer:	www.inseeego.com

Below this is a 'Customer Support' section with the following contact information:

Online:	support@inseeego.com
Telephone:	877.698.6481

3

Advanced Settings

Overview

Using Advanced Settings

Overview

Advanced Settings are intended for users with technical expertise in the area of telecommunication and networking.

WARNING! Changing the Advanced settings may be harmful to the stability, performance, and security of the S2000e.

Using Advanced Settings

When you select the **Advanced** tab on the Settings page, a warning message appears. If you click **Continue**, the Cellular tab of the Advanced Settings page appears.

Advanced Settings include the following:

- Cellular
- Manual DNS
- SIM
- LAN
- WAN Settings (Inseego Connect only)
- Firewall
- MAC Filter
- Port Filtering
- Port Forwarding
- Inseego Connect
- HTTPS
- Remote Admin

Cellular Tab

Use this tab to enable automatic network selection or manually select a network.

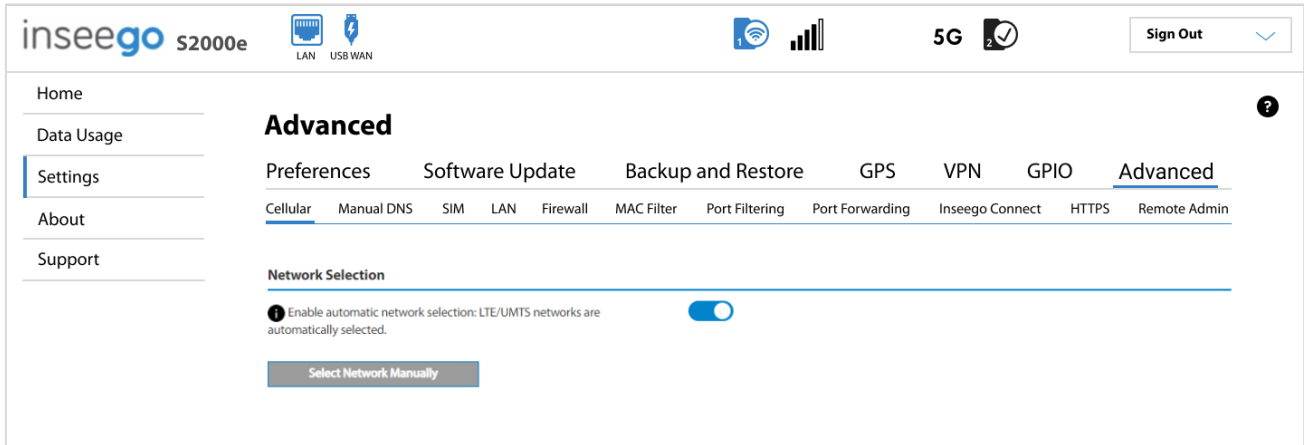

Network Selection

Enable automatic network selection: When the **ON/OFF** slider is **ON**, your S2000e automatically selects the best 5G available network and you cannot use the **Select Network Manually** button below.

Select Network Manually: You may wish to use this option if multiple networks are available and you have a preference. **NOTE:** This option is available only if **Enable automatic network selection** is off. Click the button to scan for available networks, then choose the preferred network.

Manual DNS Tab

The S2000e automatically selects a Domain Name Server (DNS). This page allows you to manually assign up to two DNS IP addresses.

The screenshot shows the 'Manual DNS' configuration page for the inseeego S2000e. The page includes a navigation sidebar on the left with options: Home, Data Usage, Settings, About, and Help. The main content area is titled 'Settings' and has several sub-tabs: Preferences, Software Update, Backup and Restore, GPS, GPIO, and Advanced. Under the 'Advanced' sub-tab, there are further sub-tabs: Cellular, Manual DNS, SIM, LAN, Firewall, MAC Filter, Port Filtering, Port Forwarding, InseeGo Connect, HTTPS, and Remote Admin. The 'Manual DNS' sub-tab is selected. The page content includes the following text and form elements:

- Manual DNS**
- Your device automatically selects a Domain Name Server (DNS) or you can manually set one.
- Turn on manual DNS:
- DNS 1 IP address:
- DNS 2 IP address:
- [Save Changes](#)

Manual DNS

Turn on manual DNS: Check this box to manually select a DNS.

DNS 1 IP address: Enter the IP address for the primary DNS. This address is required to use the Manual DNS feature.

DNS 2 IP address: Enter the IP address for the secondary (backup) DNS. This address is optional and may be left blank if desired.

Click **Save Changes**.

SIM Tab

On the Admin Web UI Home page, the SIM Status panel shows SIM status information.

The screenshot displays the Admin Web UI for the inseeego S2000e gateway. The top navigation bar includes the logo, LAN/USB WAN icons, signal strength, 5G connectivity, and a 'Sign Out' button. The main content area is divided into several sections:

- Navigation Menu:** Home, Data Usage, Settings, About, Support.
- Welcome Message:** 'Welcome To Your S2000e Gateway' with an image of the gateway device.
- Data Usage:** A circular progress indicator shows 85% data usage (8.5 GB of 10.0 GB plan). A bar chart shows 1.5 GB data used and 8.5 GB data remaining.
- SIM Status (highlighted in red):**

SIM 1 (IMSI - 310120265624299, Active)		
Carrier:	ECGI:	xxxx
ICCID:	RSRP:	xxxx
IMSI:	RSRQ:	xxxx
MDN:	SNR:	xxxx
APN:	PCI:	xxxx
- General Status:**

Model:	S2000e-3
Technology:	LTE
Band:	DC_2A-2A-12A-30A_n66A
WAN Status:	Available
SIM Status:	Connected
FW Version:	xxxx
IPv4:	192.168.1.1
IPv6:	2001:0db8:85a3:0000:0000:8a2e:0370:7334
IMEI:	xxxx
MAC Address:	AA:BB:CC:DD:EE

Carrier: The name of the Mobile Network Operator.

ICCID: The unique ID number assigned to the SIM card.

IMSI: The International Mobile Subscriber Identity (IMSI) for your S2000e. This is a unique number, usually fifteen digits, that identifies a Global System for Mobile Communications (GSM) subscriber.

MDN: The phone number of your S2000e.

APN: The access point name for your S2000e.

ECGI: E-UTRAN Cell Global Identifier. This is a 15-digit code used to identify cells globally.

RSRP: The strength of the cellular signal, measured in dBm. Higher absolute values indicate a stronger signal, for example: -80 dBm is a stronger signal than -90 dBm.

RSRQ: Reference Signal Received Quality. A calculated value from RSRP and RSSI that provides a measure of signal and interference.

SNR: Signal to Noise Ratio. A ratio of signal power to noise power expressed in decibels. SNR is a positive value, and higher numbers are better.

PCI: The Physical Cell ID.

NOTE: SIM Management settings vary depending on whether you are using the Admin Web UI or InseeGo Connect. The following sections provide information on each:

- SIM Tab (Admin Web UI)
- SIM Management (InseeGo Connect)

SIM Tab (Admin Web UI)

To turn on automatic SIM switching or enter a SIM PIN, select **Settings** from the side menu. Then select **Advanced >SIM**.

The screenshot displays the Inseego S2000e Admin Web UI. The top navigation bar includes 'Home', 'Data Usage', 'Settings', 'About', and 'Support'. The 'Settings' menu is expanded, showing 'Advanced' selected. The 'Advanced' menu includes 'Preferences', 'Software Update', 'Backup and Restore', 'GPS', 'VPN', 'GPIO', and 'Advanced'. The 'SIM Management' section is active, showing a toggle for 'Turn ON Automatic SIM Switching' which is turned on. Below this is a 'Status' section with a note: 'Note: Changing the active SIM will immediately take effect.' A table lists two SIM slots:

Active	SIM Slot	IMSI	Carrier	Connection Status	PIN Lock	Priority
<input checked="" type="radio"/>	1	310410210707294		Connected	Off	Preferred
<input type="radio"/>	2	311580712035149		Ready	Off	Normal

Below the table are fields for APN (broadband), Authentication (None), and Desired Action (Select). A warning message states: '3 attempts remain until your SIM is permanently locked.' A note below reads: 'Note: Entering an incorrect PIN too often will permanently lock your SIM and you will be unable to use the Device. You will need to contact your carrier customer support to unlock the SIM.' A 'Save Changes' button is at the bottom.

NOTE: The SIM card in your S2000e can be locked using a PIN. If the SIM card is locked, you must enter the PIN before connecting to the mobile network. Once entered, the PIN is remembered until the next shutdown. You may also need to provide the existing PIN to change a SIM. The default PIN is available from your service provider.

To change SIM settings, follow this process:

1. Select the SIM you want to update by clicking **Active**.
2. Update the settings.
3. Select the next SIM you want to update and update the settings.
4. Select the primary SIM by clicking **Active**.

NOTE: Additional settings can be configured with Inseego Connect.

SIM Management

Turn ON Automatic SIM Switching: Move the **ON/OFF** slider to **ON** to turn on automatic SIM switching. When enabled, the SIM is switched automatically if the active SIM is disconnected. When **OFF**, you can manually switch between SIMs.

Status

Active: Select the SIM you want to be active. **NOTE:** The change will take effect immediately.

SIM Slot: The SIM slot number.

IMSI: The International Mobile Subscriber Identity (IMSI) for the SIM. This is a unique number, usually fifteen digits, that identifies a Global System for Mobile Communications (GSM) subscriber.

Carrier: The cellular carrier associated with the SIM.

Connection Status: The current status of the SIM.

PIN Lock: If On, the PIN lock has been turned on, and the SIM PIN must be entered to connect to the mobile network. If Off, the PIN lock feature is not turned on and the SIM PIN is not required.

Priority: Indicates whether the SIM is Normal or Preferred priority.

APN: Enter the APN for your private network on this SIM. In most configurations, the S2000e is used with a dynamic IP and SIM and the Access Point Name (APN) is available from the network, for example: *internet*. However, if you are on a private network, you may need to set the APN for the network to communicate with the S2000e.

CAUTION! Changing the APN may cause a loss of data connectivity.

Authentication: Select the authentication method for your private network on this SIM from the drop-down (PAP, CHAP, PAP/CHAP, or None).

Username: Enter the user name for your private network on this SIM.

Password: Enter the password for your private network on this SIM.

Desired Action: The actions available depend on the SIM status. **NOTE:** Automatic SIM switching must be turned off to take these actions.

Possible operations include:

- **Turn on PIN Lock** - Sets the SIM so that entry of a PIN is required upon startup to connect to the mobile network. To perform this operation, you must enter the current PIN.
- **Turn off PIN Lock** - Turns off a PIN lock that was previously turned on so that entry of a PIN is no longer required to connect to the mobile network. To perform this operation, you must enter the current PIN.
- **Change PIN** – Allows you to change the SIM PIN by entering the current PIN and then entering and confirming the new PIN.

Current PIN: Enter the current PIN. **NOTE:** The default SIM PIN is available from your service provider.

Click **Save Changes**.

SIM Management (Inseego Connect)

NOTE: These SIM Management settings are available with Inseego Connect, which allows you to configure multiple devices at once, under **Mobile Network > SIM Management**. You can enable roaming, automatic SIM switching, SIM failback, and signal strength switching, as well as configure each SIM.

SIM Management

Global SIM Settings

Roaming Enabled

Enable Auto SIM Switching

SIM Failback

SIM Failback Interval minutes

Enabled SignalStrength Switching

SIM Configuration

	SIM 1 (Active)	SIM 2
Priority	<input checked="" type="radio"/>	<input type="radio"/>
IMSI	315010002314649	311480597184817
ICCID	89105212222000046487	89148000005907238869
Carrier		

PTN

	SIM 1 (Active)	SIM 2
Cycle Start Date	<input type="text" value="1"/>	<input type="text" value="1"/>
Data Limit	<input type="text" value="10"/> GB	<input type="text" value="10"/> GB
APN	<input type="text"/>	<input type="text"/>
Authentication	<input type="text" value="None"/>	<input type="text" value="None"/>
UserName	<input type="text"/>	<input type="text"/>
Password	<input type="text"/>	<input type="text"/>
Signal Strength	<input type="text" value="-110"/> dbm	<input type="text" value="-110"/> dbm
Signal Strength Failover Timer	<input type="text" value="45"/> Seconds	<input type="text" value="45"/> Seconds

WARNING: Entering an APN that is not supported by the SIM card's carrier will prevent your device from connecting to the internet. You will NOT be able to fix this remotely using Inseego Connect.

Schedule later

Global SIM Settings

Roaming Enabled: When the **ON/OFF** slider is **ON**, roaming is enabled.

Enable Auto SIM Switching: When enabled, the SIM automatically switches if the primary (active) SIM loses connectivity.

SIM Failback: When enabled, if the SIM switches to the backup SIM, the failback mechanism checks the primary SIM at a specified frequency (set in **SIM Failback Interval**). When the primary SIM is found to be active (and meets the signal strength threshold, if **Enable SignalStrength Switching** is on), the SIM switches back to the primary SIM.

SIM Failback Interval: The frequency at which you want the Failback mechanism to check the primary SIM when the SIM Manager has switched to the backup SIM.

Enable Signal Strength Switching: When enabled, the SIM automatically switches if signal strength falls below the threshold (dBm) set in **Signal Strength** for the amount of time set in **Signal Strength Failover Timer** for the SIM.

SIM Configuration

Priority: Select the SIM you want to be primary (active).

IMSI: The International Mobile Subscriber Identity (IMSI) for the SIM.

ICCID: The unique ID number assigned to the SIM card.

Carrier: The name of the Mobile Network Operator (MNO) for the SIM.

PTN: The Private Telecommunication Network (PTN) number for the SIM.

Cycle Start Date: The day of the month the billing cycle starts for the SIM.

Data Limit: The amount of data the SIM is limited to each billing cycle.

APN: In most configurations, the S2000e is used with a dynamic IP and SIM and the Access Point Name (APN) is available from the network, for example: *internet*. However, if you are on a private network, you may need to set the APN for the network to communicate with the S2000e. Enter the APN for your private network with this SIM.

CAUTION! Changing the APN may cause a loss of data connectivity.

Authentication: Select the authentication method for the private network with this SIM from the drop-down (PAP, CHAP, or None).

User Name: The user name for your private network with this SIM.

Password: The password for your private network with this SIM.

Signal Strength: The threshold signal strength at which you want the SIM to switch automatically. When signal strength falls below this threshold for the amount of time specified in **Signal Strength Failover Timer**, failover occurs to the other SIM. **NOTE:** Higher absolute values for signal strength indicate a stronger signal, for example: -80 dBm is a stronger signal than -90 dBm.

Signal Strength Failover Timer: Enter the amount of time signal strength must remain below the threshold set in **Signal Strength** to trigger an automatic SIM switch.

If you want the changes enacted at a later time, check the **Schedule later** box and select a date and time from the calendar. Once all your changes are made, select **Save to Device**.

LAN Tab

This page provides settings and information about the S2000e local area network (LAN). The LAN consists of the device and all connected devices.

The screenshot shows the inseeego S2000e web interface. The top navigation bar includes 'Home', 'Data Usage', 'Settings', 'About', and 'Support'. The 'Settings' menu is expanded to show 'Advanced' settings. The 'Advanced' tab is selected, and the 'LAN' sub-tab is active. The page displays the following sections:

- IP Passthrough:** A checkbox labeled 'Turn on IP Passthrough:' is checked. Below it, a dropdown menu for 'IPPT Interface:' is set to 'Ethernet'. A note states: 'If enabled, one device (the first device detected) on the selected interface will obtain the Internet IP address assigned by the mobile network. All other devices will lose Internet access.'
- IPv4:** Fields for 'IP Address:' (192.168.1.1), 'Subnet Mask:' (255.255.255.0), and 'MAC Address:' (AA:BB:CC:DD:EE:FF). A checkbox for 'Turn on DHCP server:' is checked. Fields for 'DHCP Lease Time:' (1440), 'Start DHCP Address Range at:' (192.168.1.1), and 'End DHCP Address Range at:' (192.168.1.1).
- IPv6:** A checkbox for 'Turn on IPv6:' is checked. A note says: 'Note: When on, connected devices can make IPv6 connections to the Internet'. The 'Link Local Address:' is fe08::78c6:fbff:facecca1.
- Gateway Configuration:** A dropdown for 'Gateway Settings:' is set to 'Configure gateway and netmask manually'. Fields for 'Gateway IP Address:' and 'Gateway Subnet Mask:' are empty.

A blue 'Save Changes' button is located at the bottom of the settings area.

IP Passthrough

Turn on IP Passthrough: Check the box to enable IP Passthrough (IPPT). This passes the IP address assigned by the mobile network to the connected host routing system, enabling a one-to-one connection from the WAN connection on the gateway to the host routing system. This is beneficial in SD-WAN implementations to allow the host routing system to fully manage the firewall and all routing settings on the network.

NOTE: When IP Passthrough is on, only one device will have internet access. All other connected devices will be disconnected and lose internet access. The following capabilities are set through the host routing system and Web UI settings are not available:

- DMZ (Firewall)
- Port Filtering
- Port Forwarding

IPPT Interface: Select an interface from the drop-down. **NOTE:** IPPT can be enabled over Ethernet or USB, and when enabled, the other interface is disabled.

IPv4

IP Address: The IP address for your S2000e, as seen from the local network. Normally, you can use the default value.

Subnet Mask: The subnet mask network setting for the S2000e. The default value 255.255.255.0 is standard for small (class "C") networks. If you change the LAN IP Address, make sure to use the correct Subnet mask for the IP address range of the LAN IP address.

MAC Address: (read-only) The Media Access Controller (MAC) Address for your S2000e. The MAC address is a unique network identifier assigned when a network device is manufactured.

Turn on DHCP server: This checkbox turns the DHCP Server feature on or off. This should be left checked. The DHCP server allocates an IP address to each connected device. **NOTE:** If the DHCP Server is turned off, each connected device must be assigned a fixed IP address.

DHCP Lease Time: The number of minutes in which connected devices must renew the IP address assigned to them by the DHCP server. Normally, this can be left at the default value, but if you have special requirements, you can change this value.

Start DHCP Address Range at: The start of the IP address range used by the DHCP server. If the IP is set on the client device, use an IP address outside of this DHCP range; if the IP address is set using an IP reservation, it will usually be inside this range. **NOTE:** Only expert users should change this setting.

End DHCP Address Range at: The end of the IP address range used by the DHCP server. If the IP is set on the client device, use an IP address outside of this DHCP range; if the IP address is set using an IP reservation, it will usually be inside this range. **NOTE:** Only expert users should change this setting.

IPv6

Turn on IPv6: Check the box if the connected device supports IPv6. This enables IPv6 connected devices to make IPv6 connections to the Internet. **NOTE:** The local Web UI address (<http://inseego.local/>) relies on having IPv6 enabled on your connecting device.

Link-Local Address: The Link-Local IPv6 address if the connected device supports IPv6.

Gateway Configuration

Gateway Settings: Use the drop-down to select a configuration (Use gateway and netmask from modem, Use default gateway and netmask from modem, or Configure gateway and netmask manually). If you select **Configure gateway and netmask manually**, you are prompted to enter a gateway IP Address and Subnet mask.

Click **Save Changes** to activate and save new settings.

WAN

NOTE: WAN settings are available only with Inseego Connect.

Use this page to enable and configure WAN keep alive.

The screenshot shows a 'Configure' window for WAN settings. On the left is a navigation menu with options: Device, Mobile Network, GPS, Connected Devices, Advanced (selected), Firewall, MAC Filter, LAN, WAN, Port Filtering, and Port Forwarding. The main area is titled 'WAN' and contains the following settings:

Setting	Value	Unit
Enable WAN Keep Alive	ON	
Lookup Address 1 *	www.google.com	
Lookup Address 2 *	www.yahoo.com	
Lookup Address 3 *	www.inseego.com	
Keep Alive Interval *	86400	(seconds)
Number Of Attempts *	3	
Retry Interval *	10	(seconds)
Enable WAN Failover	ON	
WAN Failover Validation Interval *	1440	(minutes)
Enable WAN Fallback	OFF	
Fallback Interval *	60	(minutes)

At the bottom of the window, there are buttons for 'Schedule later', 'Select Date Tin', 'Cancel', and 'Save to Device'.

WAN

Enable WAN Keep Alive: If ON, keep alive verifies lookup addresses to check the internet connectivity on the WAN connection.

Lookup Address 1: Enter the first DNS IP address to verify the WAN connection.

Lookup Address 2: Enter the second DNS IP address to verify (if Lookup Address 1 does not respond with keep alive acknowledgement (ACK)).

Lookup Address 3: Enter the third DNS IP address to verify (if Lookup Address 2 does not respond with keep alive ACK).

Keep Alive Interval: Enter the desired number of seconds without receiving a valid packet before the first keep alive verification occurs.

Number of Attempts: Enter the number of times to retry after verification failure for all three lookup addresses.

Retry Interval: Enter the number of seconds between verification retries.

NOTE: Other fields may be visible on this page that are not applicable to S2000e WAN configuration.

Firewall Tab

The S2000e firewall determines which Internet traffic is allowed to pass between the gateway and connected devices and protects your connected devices from malicious incoming traffic from the Internet. The firewall cannot be turned off. Use the Firewall tab to adjust the general security level of the firewall, designate a specific device to receive all traffic, and set up specific firewall rules.

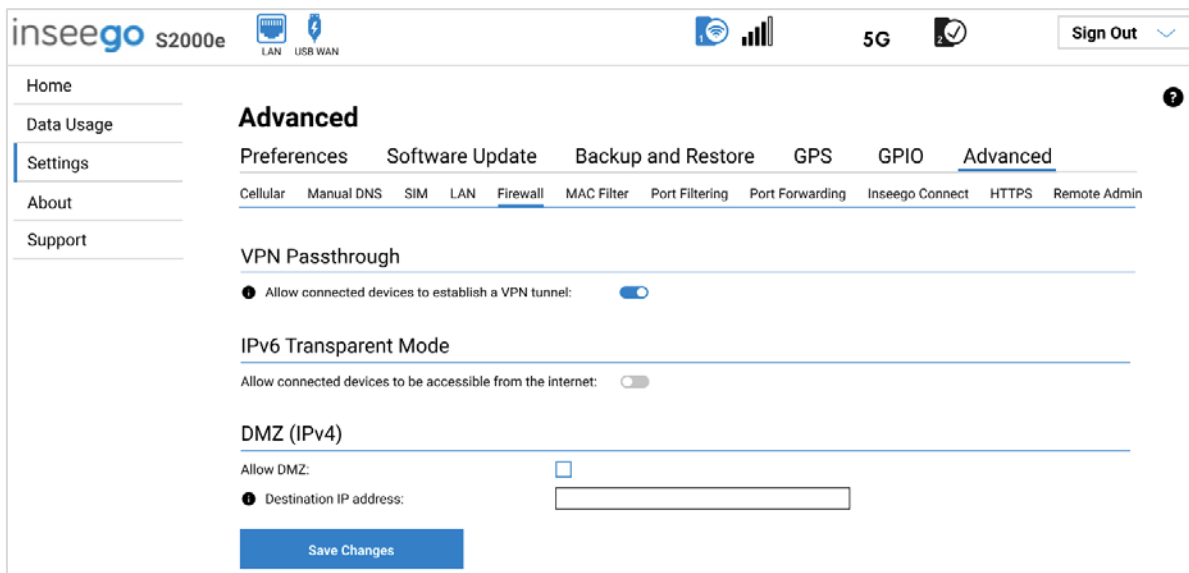

VPN Passthrough

To use the **VPN Passthrough**, ensure the **ON/OFF** slider is **ON**. This allows you to establish a VPN tunnel while using your S2000e.

IPv6 Transparent Mode

To use **IPv6 Transparent Mode**, move the **ON/OFF** slider to **ON**. This allows connected devices to be accessible from the Internet on their IPv6 address.

DMZ (IPv4)

NOTE: When IP Passthrough is turned on, DMZ capabilities are set through the connected host routing system. Settings in this section are not available. Go to **Advanced > LAN** to turn IP Passthrough off.

Allow DMZ: Check this box to allow DMZ. DMZ allows the connected device specified as the DMZ IP address (Destination IP address) to receive all traffic that would otherwise be blocked by the firewall.

NOTE: Allowing DMZ may assist some troublesome network applications to function properly, but the DMZ device should have its own firewall to protect itself against malicious traffic.

Destination IP address: Enter the IP address of the connected device you wish to become the DMZ device (the DMZ destination). **NOTE:** You can check the IP address of each connected device on the Connected Devices screen.

Click **Save Changes**.

MAC Filter Tab

The MAC filter allows only selected devices to access the S2000e network through DHCP. By default, MAC filter is turned off.

Use this tab to turn the MAC Filter on and specify device access.

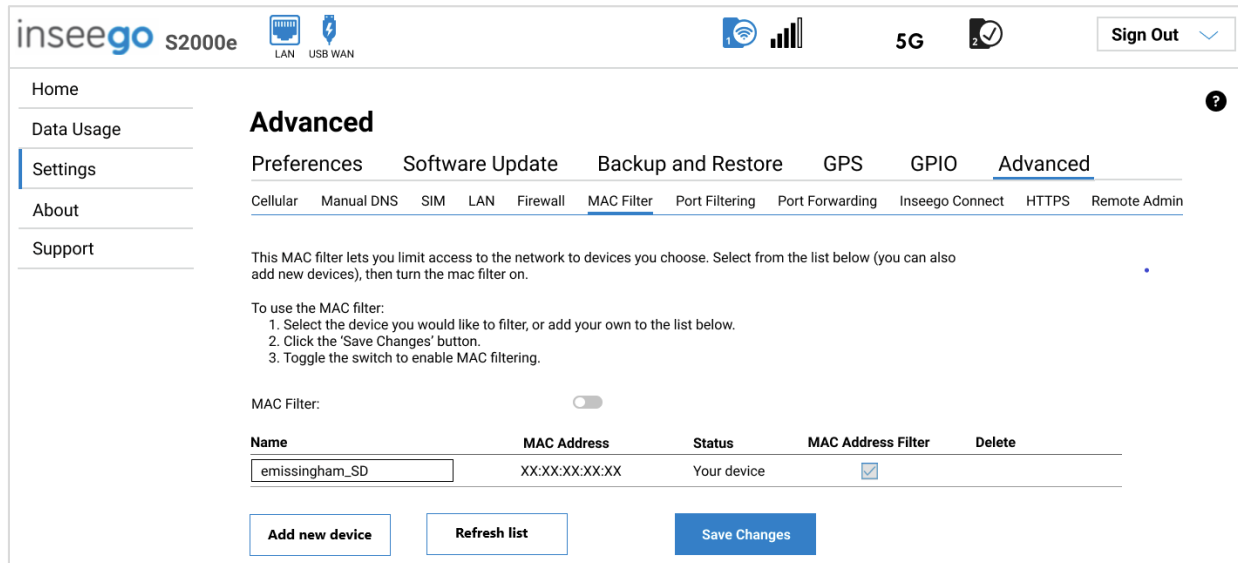

MAC Filter

To use the MAC filter, select the device(s) from the device list that you want to be allowed to connect to the network through DHCP and move the **MAC Filter ON/OFF** slider to **ON**. Click **Save Changes**.

CAUTION! Turning on MAC filtering immediately disconnects all devices that are not included in the filter from the network.

Device List

This list includes all devices currently connected to the S2000e.

Add new device: Use this button to add a device to the device list, then enter the device name, MAC address, choose whether to select the **MAC Address Filter** checkbox, and click **Save Changes**.

To delete a device from the list, select its **Delete** checkbox and click **Save Changes**.

To discard any unsaved changes and refresh the list, click **Refresh list** and **Confirm**.

Port Filtering Tab

Port Filtering allows you to block outgoing Internet connections and permit only selected applications to access the Internet. Traffic is identified by port numbers. Some applications are pre-defined. You can define additional applications if you know the details of the traffic used and generated by the applications.

The screenshot shows the inseeego S2000e web interface. The top navigation bar includes the logo, model number, connection icons (LAN, USB WAN), signal strength, 5G indicator, and a Sign Out button. The left sidebar contains links for Home, Data Usage, Settings (highlighted), About, and Support. The main content area is titled 'Advanced' and contains sub-tabs for Preferences, Software Update, Backup and Restore, GPS, GPIO, and Advanced (selected). Under the 'Advanced' sub-tab, there are links for Cellular, Manual DNS, SIM, LAN, Firewall, MAC Filter, Port Filtering (selected), Port Forwarding, Inseeego Connect, HTTPS, and Remote Admin. The Port Filtering section includes a toggle switch currently set to 'OFF' and a note: 'If Port Filtering is on, only traffic from selected applications can access the internet. Note: DNS is always allowed.' Below this is the 'Applications' section with a list of checkboxes for Email (POP3, IMAP, SMTP), FTP, HTTP, HTTPS, and Telnet. The 'Custom Applications' section includes a table with columns for On, Application Name, Start Port, End Port, Protocol, and Delete. Two custom applications are listed: 'App 1' and 'App 2', both with 'TCP' protocol. At the bottom, there are buttons for 'Add Custom Application' and 'Save Changes'.

inseeego S2000e LAN USB WAN 5G Sign Out

Home
Data Usage
Settings
About
Support

Advanced

Preferences Software Update Backup and Restore GPS GPIO Advanced

Cellular Manual DNS SIM LAN Firewall MAC Filter Port Filtering Port Forwarding Inseeego Connect HTTPS Remote Admin

If Port Filtering is on, only traffic from selected applications can access the internet.
Note: DNS is always allowed.

Port Filtering:

Applications

Select which applications can access the internet.

- Email (POP3, IMAP, SMTP)
- FTP
- HTTP
- HTTPS
- Telnet

Custom Applications

You can define your own applications, and then turn them on or off as needed. To define an application, you need to know the outgoing ports used by the application.

On	Application Name	Start Port	End Port	Protocol	Delete
<input checked="" type="checkbox"/>	App 1			TCP	<input type="checkbox"/>
<input checked="" type="checkbox"/>	App 2			TCP	<input type="checkbox"/>

Add Custom Application Save Changes

NOTE: When IP Passthrough is turned on, port filtering capabilities are set through the connected host routing system. Settings on this page are not available. Go to **Advanced > LAN** to turn IP Passthrough off.

Port Filtering

To turn on Port Filtering, move the **ON/OFF** slider to **ON**. To turn off Port Filtering, so that any application can connect to the Internet, move the slider to **OFF**.

Applications

Select the applications you want to be able to access the Internet.

The following table provides port numbers and protocol information for each Port Filtering application listed.

Application Name	Port	TCP*	STCP*	UDP*
Email				
POP3	110	Yes	No	Assigned
POP3S	995	Yes	No	Yes
IMAP	143	Yes	No	Assigned
IMAPS	993	Yes	No	Assigned
SMTP	25	Yes	No	Assigned
SecureSMTP	465	Yes	No	No
FTP control (command)	21	Yes	Yes	Assigned
FTP data transfer	20	Yes	Yes	Assigned
HTTP	80	Yes	Yes	Assigned
HTTPS	443	Yes	Yes	Assigned
Telnet	23	Yes	No	Assigned

Custom Applications

Add Custom Application: Use this button to add a new row to the custom application list.

Custom Applications
✕

You can define your own applications, and then turn them on or off as needed. To define an application, you need to know the outgoing ports used by the application.

On	App Name	Start Port	End Port	Protocol	Delete
<input checked="" type="checkbox"/>	<input type="text" value="App 1"/>	<input type="text"/>	<input type="text"/>	TCP ▾	<input type="checkbox"/>
<input checked="" type="checkbox"/>	<input type="text" value="App 2"/>	<input type="text"/>	<input type="text"/>	TCP ▾	<input type="checkbox"/>

Cancel

Save Changes

* **Yes** indicates the protocol is standardized for the port number.

No indicates the protocol is standardized for the port number.

Assigned indicates the port number is assigned by IANA (Internet Assigned Numbers Authority) for protocol use, but may not be standardized.

- **On:** Check this box if you want the new application to be able to access the Internet.
- **App Name:** Enter a name for the custom application.
- **Start Port:** Enter the beginning of the range of port numbers used by outgoing traffic for the custom application being added.
- **End Port:** Enter the end of the range of port numbers used by the application.
NOTE: If the application uses a single port instead of a range, type the same value for both the **Start Port** and the **End Port**.
- **Protocol:** Select the protocol used by the port range from the drop-down list (TCP, UDP, or both).
- **Delete:** Check this box to delete a custom application. **NOTE:** Click on the Port Filtering tab again to remove deleted custom applications from view on the screen.

Click **Save Changes** to save any changes made to the custom applications.

Port Forwarding Tab

Port Forwarding allows specific applications to be forwarded to a particular device connected to your network. Normally, the built-in firewall blocks incoming traffic from the Internet. Port Forwarding allows Internet users to access any server you are running on your computer, such as a Web, FTP, or Email server.

Important: Port Forwarding creates a security risk and should not be turned on unless it is required.

Some mobile networks provide you with an IP address on their own network rather than an Internet IP address. In this case, Port Forwarding cannot be used, because Internet users cannot reach your IP address.

The screenshot shows the 'Advanced' settings page for the inseeego S2000e device. The 'Port Forwarding' tab is selected, and the 'Port Forwarding' toggle is currently turned off. Below this, there is a table of pre-defined applications with checkboxes and IP address input fields. At the bottom, there is a table for 'Custom Applications' with columns for 'On', 'Application Name', 'IP Address', 'Port Type', 'Port Numbers', 'Protocol', and 'Delete'. Two custom applications are listed: 'Custom App 1' and 'Custom App 2', both with 'Range' port types and 'TCP' protocols. Buttons for 'Add Custom Application' and 'Save Changes' are visible at the bottom.

Application	Application IP address
<input type="checkbox"/> DNS	
<input checked="" type="checkbox"/> FTP	
<input type="checkbox"/> HTTP/HTTPS	
<input type="checkbox"/> NNTP	
<input type="checkbox"/> POP3/POP3S	
<input type="checkbox"/> SMTP/Secure SMTP	
<input type="checkbox"/> SNMP	
<input type="checkbox"/> Telnet	
<input type="checkbox"/> TFTP	

On	Application Name	IP Address	Port Type	Port Numbers	Protocol	Delete
<input checked="" type="checkbox"/>	Custom App 1		Range	From: <input type="text"/> To: <input type="text"/>	TCP	<input type="checkbox"/>
<input checked="" type="checkbox"/>	Custom App 2		Range	From: <input type="text"/> To: <input type="text"/>	TCP	<input type="checkbox"/>

NOTE: When IP Passthrough is turned on, port forwarding capabilities are set through the connected host routing system. Settings on this page are not available. Go to **Advanced > LAN** to turn IP Passthrough off.

Port Forwarding

Port Forwarding: To turn on Port Forwarding, move the **ON/OFF** slider to **ON**. To turn off Port Forwarding, so that no inbound traffic is forwarded to a LAN client, move the slider to **OFF**.

Applications

Check the box next to each Port Forwarding application that you want to allow.

To forward all inbound WAN traffic on a specific port to a single LAN client, enter the IP address of the target device in the **Application IP Address** field.

The following table provides port numbers and protocol information for each Port Forwarding application listed.

Application Name	Port	TCP*	STCP*	UDP*
DNS	53	Yes	No	Yes
FTP control (command)	21	Yes	Yes	Assigned
FTP data transfer	20	Yes	Yes	Assigned
HTTP	80	Yes	Yes	Assigned
HTTPS	443	Yes	Yes	Assigned
NNTP	119	Yes	No	Assigned
POP3	110	Yes	No	Assigned
POP3S	995	Yes	No	Yes
SMTP	25	Yes	No	Assigned
SecureSMTP	465	Yes	No	No
SNMP	161	Assigned	No	Yes
Telnet	23	Yes	No	Assigned
TFTP	69	Assigned	No	Yes

* **Yes** indicates the protocol is standardized for the port number.

No indicates the protocol is not standardized for the port number.

Assigned indicates the port number is assigned by IANA (Internet Assigned Numbers Authority) for protocol use, but may not be standardized.

Custom Applications

You can add up to ten custom applications. Once defined, these applications can be turned on and off the same way as pre-defined applications.

Custom Applications ✕

You can define your own applications, and then turn them on or off as needed. To define an application, you need to know the outgoing ports used by the application.

On	App Name	Start Port	End Port	Protocol	Delete
<input checked="" type="checkbox"/>	<input type="text" value="App 1"/>	<input type="text"/>	<input type="text"/>	<input type="text" value="TCP"/>	<input type="checkbox"/>
<input checked="" type="checkbox"/>	<input type="text" value="App 2"/>	<input type="text"/>	<input type="text"/>	<input type="text" value="TCP"/>	<input type="checkbox"/>

- **On:** Check this box if you want the new application to be able to access the Internet (enabling Port Forwarding).
- **App Name:** Enter a name for the custom application.
- **Start Port:** Enter the beginning of the range of port numbers to be forwarded.
- **End Port:** Enter the end of the range of port numbers to be forwarded.
NOTE: If the application uses a single port instead of a range, type the same value for both the **Start Port** and the **End Port**.
- **Protocol:** Select the protocol used by the port range from the drop-down list (TCP, UDP, or both).
- **Delete:** Check this box to delete a custom application. **NOTE:** Click on the Port Forwarding tab again to remove deleted custom applications from view on the screen.

Click **Save Changes** to save any changes made to the custom applications.

Inseego Connect Tab

Use this page to enable and configure settings for connection with Inseego Connect. Inseego Connect is a cloud platform product that provides 360 degree visibility and secure accessibility into your deployment from a single platform.

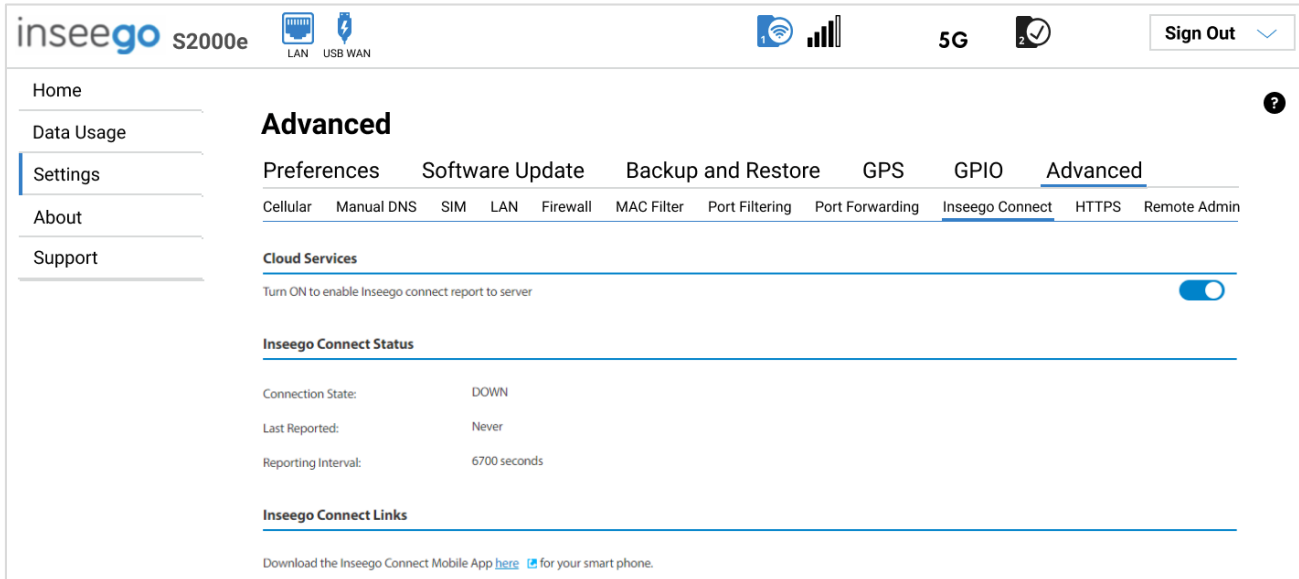

The screenshot shows the Inseego S2000e web interface. The top navigation bar includes the Inseego logo, model number S2000e, and connection status icons for LAN, USB WAN, Wi-Fi, cellular signal, 5G, and a checkmark. A 'Sign Out' button is in the top right. The left sidebar contains links for Home, Data Usage, Settings (highlighted), About, and Support. The main content area is titled 'Advanced' and has sub-tabs for Preferences, Software Update, Backup and Restore, GPS, GPIO, and Inseego Connect (selected). Under 'Inseego Connect', there are sub-tabs for Cellular, Manual DNS, SIM, LAN, Firewall, MAC Filter, Port Filtering, Port Forwarding, Inseego Connect, HTTPS, and Remote Admin. The 'Cloud Services' section has a toggle switch turned ON with the text 'Turn ON to enable Inseego connect report to server'. The 'Inseego Connect Status' section shows: Connection State: DOWN, Last Reported: Never, and Reporting Interval: 6700 seconds. The 'Inseego Connect Links' section has a link to download the mobile app: 'Download the Inseego Connect Mobile App [here](#) for your smart phone.'

Cloud Services

By default, the connection to Inseego Connect is **ON**. Slide the ON/OFF slider to **OFF** if you wish to disable the connection.

Inseego Connect Status

Connection State: The status of the Inseego Connect connection.

- **UP** – S2000e is communicating with Inseego Connect servers.
- **DOWN** – S2000e is NOT communicating with Inseego Connect servers.

Last Reported: The time when S2000e last sent a packet to Inseego Connect servers.

Reporting Interval: This is the interval at which your S2000e will send packets to the Inseego Connect server. **NOTE:** A shorter interval means more data usage.

Inseego Connect Links

Use the link to download the Inseego Connect Mobile App.

HTTPS Tab

Use this tab to enable HTTPS access to this Admin Web UI. You can configure HTTPS and obtain an SSL certificate for a secure connection.

NOTE: Enabling HTTPS allows for secure access to the Admin Web UI and is a prerequisite to support Remote Administration.

The screenshot shows the Admin Web UI for an inseeo S2000e device. The top navigation bar includes the inseeo logo, device model 'S2000e', and status icons for LAN, USBWAN, Wi-Fi, cellular signal, and 5G. A 'Sign Out' button is in the top right. The left sidebar contains a menu with 'Home', 'Data Usage', 'Settings' (highlighted), 'About', and 'Support'. The main content area is titled 'Advanced' and has sub-tabs for 'Preferences', 'Software Update', 'Backup and Restore', 'GPS', 'VPN', 'GPIO', and 'Advanced' (selected). Under the 'Advanced' sub-tab, there are further options: 'Cellular', 'Manual DNS', 'SIM', 'LAN', 'Firewall', 'MAC Filter', 'Port Filtering', 'Port Forwarding', 'Inseeo Connect', 'HTTPS' (selected), and 'Remote Admin'. The 'Enable HTTPS support' toggle is currently turned off. Below this, a warning message states: 'Whenever the LAN IP is changed or device settings are restored from a backup, the "Enable HTTPS support" must be disabled, do save changes to generate and download certificate to access the web UI in HTTPS mode. Also, certificates must be generated after every factory reset.' The configuration form includes the following fields: 'Port*' (443, with a note 'Default 443 or in between 1024 to 65535'), 'Certificate name*' (with a note 'Single word without spaces'), 'Country name*', 'State or Province name*', 'Locality name*', 'Organization name*', 'Organization unit name*', 'Common name*', 'Email address*', and 'Validity*' (790, with a note 'in days'). At the bottom of the form are three buttons: 'Clear', 'Download certificate', and 'Save Changes'.

Process to enable HTTPS:

To enable HTTPS support, do the following:

1. Fill in the following information fields:

NOTE: Do not enable HTTPS with the Enable HTTPS support slider yet.

- **Port:** Use the default of 443 or enter a port number between 1024 and 65535.
- **Certificate name:** Enter a name for the self-signed SSL certificate. A certificate with this name and a .crt extension is created. You can install the certificate on the client device to enable secure connection while accessing the Admin Web UI.
- **Country name:** Enter two-letter country code (for example, US) where your company is legally located.
- **State or Province name:** Enter the state or province where your company is legally located.
- **Locality name:** Enter the city where your company is legally located. This is optional.
- **Organization name:** Enter the organization or company name to be used for the SSL certificate.
- **Organization unit name:** Enter an internal department name within the organization. This is optional.

- **Common name:** Enter the fully-qualified domain name (FQDN) (for example, www.example.com) or a suitable name to identify the certificate in a unique way. This is optional.
- **Email address:** Enter an email address to be associated with the certificate. This is optional.
- **Validity:** Enter the number of days for which the certificate is valid.

You can use the **Clear** button to clear and change entries.

2. Click **Save Changes**. The device reboots.
3. Access this page on the Web UI again and use the **Download certificate** button to download a certificate. Once you have downloaded the SSL certificate, you must install it on the client device and mark it as trusted for secure SSL connection while accessing the Admin Web UI.

Perform the following the steps based on your operating system and browser:

Windows

- a. Click on the downloaded certificate file. The Manage Certificates App automatically opens.
- b. Select **Install Certificate**.
- c. Select **Current User** or **Local Machine** and click **Next**.
- d. Select **Place all certificates in the following store** and click **Browse**.
- e. Select the **Trusted Root Certification Authorities** folder and click **OK**.
- f. Click **Finish**. A message will display that the import was successful.

Ubuntu Linux

- a. Install libnss3-tools, if not installed:

```
sudo apt-get install libnss3-tools
```
- b. Install the downloaded certificate using the following command:

```
certutil -d sql:$HOME/.pki/nssdb -A -t "CP,," -n skyuswebui.crt -i skyuswebui.crt
```

NOTE: skyuswebui is the certificate name provided when selecting Save Changes:
- c. Check installed certificates.

```
certutil -d sql:$HOME/.pki/nssdb -L
```

Mac OS

- a. Click on the downloaded certificate file. The Keychain Access App automatically opens with an Add Certificates popup.
- b. Click the **Add** button in the popup.
- c. Locate the certificate in the Certificates section.
- d. Double-click the certificate. In the **trust** section, under **When using this certificate**, select **Always Trust**.

Mozilla Firefox Browser

- a. In Firefox, type **about:config** in the address bar and click **Enter**.
- b. Accept any warnings and click **Show All**.

- c. Scroll down to **security.enterprise_roots.enabled** and click the button on the right to change the value to **true**.
- d. Restart the browser.

NOTE: In some Linux variants, with certain versions of Firefox, a warning page may display when you attempt to open the Admin Web UI url. In the warning page, select **Advanced...**, then click the button to accept and continue.

4. Move the **Enable HTTPS support** ON/OFF slider to **ON**.
5. Close your browser and re-open the Web UI. It will connect with HTTPS.

NOTE: Once enabled, if the port is 443 in HTTPS configuration, you can access the Admin Web UI at [https://\(IP address or domain name\)](https://(IP address or domain name)). For other ports, you can access at [https://\(IP address or domain name\):\(port number\)](https://(IP address or domain name):(port number)).

NOTE: Any time the LAN IP is changed, your S2000e settings are restored from backup, or your S2000e is factory reset, you must disable HTTPS support, make and save any changes to the certificate fields, and download and install a new certificate to have a secure connection.

Remote Admin Tab

Use this page to allow a remote PC or client device to access the Admin Web UI for your S2000e.

The screenshot shows the 'Advanced' settings page for the 'Remote Admin' tab. The page title is 'Advanced' and the sub-tab is 'Remote Admin'. The settings include:

- Enable remote web administration:
- WAN port: 1024-65535
- IP address type: Multiple Range
- Source public IP1:
- Source public IP2:
- Source public IP3:

A 'Save Changes' button is located at the bottom of the form.

Requirements for remote administration

To enable remote web administration, you must have the following:

1. A static IP SIM.
2. HTTPS enabled and properly set up on the **Settings > Advanced > HTTPS** page.
3. The IP address(es) or range of addresses for the computer(s) from which you want to access the Web UI remotely.

Process to enable remote administration:

To enable remote administration, do the following:

1. Move the **Enable remote web administration ON/OFF** slider to **ON**. **NOTE:** You must enable and set up HTTPS on the HTTPS page before enabling remote web administration.
2. Fill in the following fields:
 - **WAN port:** The port number associated with the WAN.
 - **IP address type:** Select the desired type of IP address – **Multiple** or **Range**.
 - If you select **Multiple** as the IP address type, enter the desired IP addresses of the computers from which you want to access the Web UI remotely in the **Source public IP** boxes.
 - If you select **Range** as the IP address type, enter the beginning of the range of IP addresses of the computers from which you want to access the Web UI remotely in the **Source public IP from** box, and the end of the range of IP addresses in the **Source public IP to** box.
3. Click **Save Changes**. Your remote computer(s) now should be able to log in using the following address: [SIM Card Static IP Address]:[Specified Port]

4

Accessories

Included Accessories

Optional Accessories

Included Accessories

Your 5G Industrial Gateway S2000e comes with a 4-pin power cable and 4-pin DC harness.

Accessory	Availability
4-pin NA AC Adapter	Included in box with NA S2000e devices
4-pin International AC Adapter	Included in box with ROW S2000e devices
4-pin DC Harness	Included in box with all S2000e devices

Optional Accessories

The following optional accessories, including antennas, brackets, and other power equipment, are available for individual purchase. To order an accessory, contact your Inseego sales representative.

Accessory	SKU
PoE Injector, 60W 5GbE Supply with AU cable	649496 02641 7
PoE Injector, 60W 5GbE Supply with EU cable	649496 02640 0
PoE Injector, 60W 5GbE Supply with NA cable	649496 02639 4
PoE Injector, 60W 5GbE Supply with UK cable	649496 02642 4
Adjustable Wall Mount Bracket Kit	649496 02617 2
DIN Rail Mount Bracket Kit	649496 02619 6
Fixed Wall Mount Bracket Kit	649496 02618 9
5G Antenna, 0.6 – 6 GHz Dipole	649496 02579 3
5G Antenna, 1.4 – 6 GHz Dipole	649496 02580 9
5G Antenna, 3.3 – 6 GHz Dipole	649496 02581 6
5G Antenna Bundle, includes 6 Antennas	649496 02620 2
5G Multi-Element Antenna 7-1 Cabinet/Enclosure	649496 02576 2

5

Product Specifications and Regulatory Information

Product Specifications

Regulatory Information

Product Certifications and Supplier's Declarations of Conformity

Wireless Communications

Limited Warranty and Liability

Safety Hazards

Product Specifications

Device	
Name:	5G Industrial Gateway S2000e
Model:	S2000e-3, S2000e-4
Regulatory:	S2000e-3 FCC, ISSED, CE, UKCA, RCM, RSM S2000e-4 MIC
Standards, Approvals, Certifications:	GCF, PTCRB EN/IEC 62368 REACH, RoHS, WEEE, Halogen Free
Dimensions:	200 x 80 x 45mm
Weight:	495 g
Ports:	1x 5 Gbps RJ45 with Power over Ethernet 1 x USB 3.1 Type C (USB Tethering, USB WAN Modem, USB to Ethernet RJ45 Adapter) 6 x Female SMA for Cellular 1 x Female SMA for GNSS 1 x 4-Pin Power with 2 x Digital I/O Pins
SIM:	2 x 4FF Nano SIM Multi-Carrier Support with Auto-Switching
Chipset:	Qualcomm® Snapdragon™ SDX55
Memory:	1 GB Flash 1 GB RAM
LED:	1 x RGB for Device Health 1 x RGB for Cellular Signal 2 x RG for SIM Status 1 x RG for USB Status 1 x RG for GNSS Status 2 x LED for Ethernet Status
Power Options:	4-Pin AC Power Supply 4-Pin DC Power and I/O Supply 60W PoE Injector, sold separately USB Power Delivery (15W Min), requires 15W from USB PD Host
Web UI OS Support:	Windows® 8, 10 Mac OS® X 10.10 or Higher Linux® Ubuntu 14.04 or Higher Chrome OS v79 or Higher

Environmental

Operating Temperature:	Device	-30°C to 65°C
	Device w/DC cable	-30°C to 65°C
	Device w/AC adapter	-10°C to 40°C

Storage Temperature: -40°C to 85°C

NOTE: The PoE injector is an indoor device that is sold separately and considered support equipment. It can operate at a maximum temperature of 35°C (95°F).

Ingress Protection: IP41

Cellular Technology

5G NR Standalone (SA) Sub6 and Non-Standalone (NSA) Sub6/mmW Support

8CC / 800 MHz mmW Max Bandwidth

200 MHz Sub6 Max Bandwidth

4G LTE CAT 22 Fallback

Dynamic Spectrum Sharing (DSS) Support

Bluetooth

Bluetooth for Inseego Mobile App Only

Positioning

L1/L5 Active GNSS Band Support

Active Antenna Support

Assisted Cellular GNSS Support

GNSS Constellations:	GPS
	GLONASS
	Galileo
	BDS

Networking

WAN with Active Keep Alive

Dual SIM with Auto-APN and Automatic Switching

Ethernet or USB IP PassThrough (IPPT, Modem Mode)

Port Forwarding

Port Filtering

MAC Filtering

DHCP

DMZ

Configurable DNS

MAC Address Filtering

Commercial and Private LTE / 5G Support

Public and Private APN Support

Security

NAT Firewall

Device Cybersecurity Agent

VPN PassThrough, OpenVPN

MACsec Ethernet Security

Security Hardened Web Interface

Fully Encrypted Log Files

Fully Encrypted Cloud Agent

Anti-CSRF

Session Timeout

Incorrect Password Lockout

Admin Portal to Block Factory Reset

Regulatory Information

Federal Communications Commission Notice (FCC – United States)

FCC ID: PKRISGS2000E3

Electronic devices, including computers and wireless modems, generate RF energy incidental to their intended function and are therefore subject to FCC rules and regulations.

This equipment has been tested to, and found to be within, the acceptable limits for a Class B digital device, pursuant to part 15 of the FCC Rules. These limits are designed to provide reasonable protection against harmful interference when the equipment is operated in a residential environment.

This equipment generates radio frequency energy and is designed for use in accordance with the manufacturer's user manual. However, there is no guarantee that interference will not occur in any particular installation. If this equipment causes harmful interference to radio or television reception, which can be determined by turning the equipment off and on, you are encouraged to try to correct the interference by one or more of the following measures.

- Reorient or relocate the receiving antenna.
- Increase the separation between the equipment and the receiver.
- Connect the equipment into an outlet on a circuit different from that to which the receiver is connected.
- Consult the dealer or an experienced radio/television technician for help.

This device complies with Part 15 of the Federal Communications Commission (FCC) Rules. Operation is subject to the following two conditions.

- This device may not cause harmful interference.
- This device must accept any interference received, including interference that may cause undesired operation.

WARNING: DO NOT ATTEMPT TO SERVICE THE WIRELESS COMMUNICATION DEVICE YOURSELF. SUCH ACTION MAY VOID THE WARRANTY. THIS DEVICE IS FACTORY TUNED. NO CUSTOMER CALIBRATION OR TUNING IS REQUIRED. CONTACT INSEEGO CORP TECHNICAL SUPPORT FOR INFORMATION ABOUT SERVICING YOUR WIRELESS COMMUNICATION DEVICE.

FCC CAUTION: Any changes or modification not expressly approved by the party responsible for compliance could void the user's authority to operate this equipment.

MODIFICATIONS: The FCC requires that you be notified that any changes or modifications made to this device that are not expressly approved by Inseego Corp. may void your authority to operate the equipment.

NOTE: The Radio Frequency (RF) emitter installed in your modem must not be located or operated in conjunction with any other antenna or transmitter, unless specifically authorized by INSEEGO CORP.

Innovation, Science and Economic Development Notice (ISED – Canada)

IC: 3229A-S2000E3

ISED RSS-Gen Notice

This device contains license-exempt transmitter(s)/receiver(s) that comply with Innovation, Science and Economic Development Canada's license-exempt RSS(s). Operation is subject to the following two conditions:

1. This device may not cause interference.
2. This device must accept any interference, including interference that may cause undesired operation of the device.

L'émetteur/récepteur exempt de licence contenu dans le présent appareil est conforme aux CNR d'Innovation, Sciences et Développement économique Canada applicables aux appareils radio exempts de licence. L'exploitation est autorisée aux deux conditions suivantes:

1. L'appareil ne doit pas produire de brouillage;
2. L'appareil doit accepter tout brouillage radioélectrique subi, même si le brouillage est susceptible d'en compromettre le fonctionnement.

ISED Canada ICES-003 Compliance

CAN ICES-3 (B)/NMB-3(B)

FCC and ISED RF Exposure Guidance Statement

In order to comply with FCC/ISED RF Exposure requirements, this device must be installed to provide at least 20 cm separation from the human body at all times.

Afin de se conformer aux exigences d'exposition RF FCC / ISED, cet appareil doit être installé pour fournir au moins 20 cm de séparation du corps humain en tout temps.

Cellular External Antenna Considerations:

1. External Antenna(s): Not Included
2. To comply with RF Exposure Requirements, the Maximum Cellular Antenna Gain Must Not Exceed:

Cellular Band	Antenna Gain (dBi) Including Cable Loss
4G-LTE: B30 (see table below)	3.0
4G-LTE: B71 5G-FR1: n71	3.1
4G-LTE: B12/B17 5G-FR1: n12	3.2
4G-LTE: B13/B42/B43/B48 5G-FR1: n78 (Canada Only)	3.5
4G-LTE: B14	3.6
3G-UMTS: B5 4G-LTE: B5/B26 5G-FR1: n5	4
4G-LTE: B41 5G-FR1: n38 (Canada Only)/n41	5
3G-UMTS: B2/B4 4G-LTE: B2/B4/B25/B66 5G-FR1: n2/n25/n66 5G-FR1: n77 (US Only)	6
4G-LTE: B7/B38 5G-FR1: n7 (Canada Only)	7

4G-LTE B30 Additional Guidance		
Max Power (dBm)	Max Antenna Gain (dBi) Allowed	Notes
24	-0.6	Please consult Inseego Corp.
23	1	
22	2	
21	3	Standard Default



Inseego Corp. declares that S2000e-3 is in Compliance with the Radio Equipment Directive 2014/53/EU, its essential requirements and other relevant provisions of the directive.

A full copy of the EU declaration of conformity is available at the following internet address:
<https://www.inseego.com/support/>.

The Declaration of Conformity may be also consulted at Inseego Corp., 9710 Scranton Rd., Suite 200 San Diego, USA.

RF Radiation Exposure Guidance Statement

This device must be installed to provide at least 20 cm separation from the human body at all times.

Radio Frequency and Transmitted Output Power Information

Band	Max Power	Frequency
WCDMA BAND I	24 dBm	1920-1980 MHz
WCDMA BAND VIII	24 dBm	880-915 MHz
LTE BAND 1	24 dBm	1920-1980 MHz
LTE BAND 3	24 dBm	1710-1785 MHz
LTE BAND 7	24 dBm	2500-2570 MHz
LTE BAND 8	24 dBm	880-915 MHz
LTE BAND 20	24 dBm	832-862 MHz
LTE BAND 28	24 dBm	703-748 MHz
LTE BAND 38	24 dBm	2570-2620 MHz
LTE BAND 40	24 dBm	2300-2400 MHz
LTE BAND 42	19.5 dBm	3400-3600 MHz
FR1 n1 (NSA)	24 dBm	1920-1980 MHz
FR1 n3 (NSA)	24 dBm	1710-1785 MHz
FR1 n7 (NSA)	24 dBm	2500-2570 MHz
FR1 n8 (NSA)	24 dBm	880-915 MHz
FR1 n20 (NSA)	24 dBm	832-862 MHz
FR1 n28 (NSA)	24 dBm	703-748 MHz
FR1 n38 (NSA)	24 dBm	2570-2620 MHz
FR1 n40 (NSA)	24 dBm	2300-2400 MHz
FR1 n78 (NSA)	24 dBm	3300-3800 MHz
Bluetooth (BLE)	4 dBm	2.4 GHz

Cellular External Antenna Considerations:

1. External Antenna(s): Not Included
2. To comply with RF Exposure Requirements, the Maximum Cellular Antenna Gain Must Not Exceed:

Cellular Band	Antenna Gain (dBi) Including Cable Loss
4G-LTE: B42 5G-FR1: n78	3.5
3G-UMTS: B8 4G-LTE: B8/B20/B28 5G-FR1: n8/n20/n28	4
3G-UMTS: B1 4G-LTE: B1/B3 5G-FR1: n1/n3	6
4G-LTE: B7/B38/B40 5G-FRA: n7/n38/n40	7

Japan Ministry of Internal Affairs and Communications (MIC)

Model: S2000e-4

This device must be installed to provide at least 20cm separation from the human body at all times.

Cellular External Antenna Considerations:

1. External Antenna(s): Not Included
2. To comply with RF Exposure Requirements, the Maximum Cellular Antenna Gain Must Not Exceed:

Cellular Band	Antenna Gain (dBi) Including Cable Loss
3G-UMTS: B1/B8 4G-LTE: B1/B3/B8/B11/B18/ B19/B21/B28/B42 5G-FR1: n77/n78/n79	3.0
4G-LTE: B41	4.0

Product Certifications and Supplier's Declarations of Conformity

Product Certifications and Supplier's Declarations of Conformity documentation may be consulted at Inseego Corp., 9710 Scranton Road Suite 200, San Diego CA 92121, USA.

<https://www.inseego.com/support/>.

Wireless Communications

IMPORTANT: Due to the transmission and reception properties of wireless communications, data occasionally can be lost or delayed.

This can be due to the variation in radio signal strength that results from changes in the characteristics of the radio transmission path. Although data loss is rare, the environment where you operate the modem might adversely affect communications.

Variations in radio signal strength are referred to as fading. Fading is caused by several different factors including signal reflection, the ionosphere, and interference from other radio channels.

Inseego Corp. or its partners will not be held responsible for damages of any kind resulting from the delays or errors in data transmitted or received with the S2000e device, or failure of the S2000e device to transmit or receive such data.

Limited Warranty and Liability

THIS LIMITED WARRANTY GIVES YOU SPECIFIC LEGAL RIGHTS, AND YOU MAY HAVE OTHER RIGHTS THAT VARY FROM STATE TO STATE (OR BY COUNTRY OR PROVINCE). OTHER THAN AS PERMITTED BY LAW, INSEEGO CORP DOES NOT EXCLUDE, LIMIT OR SUSPEND OTHER RIGHTS YOU MAY HAVE, INCLUDING THOSE THAT MAY ARISE FROM THE A PARTICULAR SALES CONTRACT.

INSEEGO CORP warrants for the 12-month period (or 24-month period if required by statute where you purchased the Product) immediately following your receipt of the Product that the Product will be free from defects in material and workmanship under normal use. TO THE EXTENT PERMITTED BY LAW, THESE WARRANTIES ARE EXPRESSLY IN LIEU OF ALL OTHER WARRANTIES, EXPRESS OR IMPLIED, INCLUDING, WITHOUT LIMITATION, ALL IMPLIED WARRANTIES OF MERCHANTABILITY AND FITNESS FOR A PARTICULAR PURPOSE.

The exclusive remedy for a claim under this warranty shall be limited to the repair or replacement, at INSEEGO CORP'S option, of defective or non-conforming materials, parts, components or the device. The foregoing warranties do not extend to (I) non conformities, defects or errors in the Products due to accident, abuse, misuse or negligent use of the Products or use in other than a normal and customary manner, environmental conditions not conforming to INSEEGO CORP'S specification, of failure to follow prescribed installation, operating and maintenance procedures, (II) defects, errors or nonconformities in the Product due to modifications, alterations, additions or changes not made in accordance with INSEEGO CORP'S specifications or authorized by INSEEGO CORP, (III) normal wear and tear, (IV) damage caused by force of nature or act of any third person, (V) shipping damage, (VI) service or repair of Product by the purchaser without prior written consent from INSEEGO CORP, (VII) products designated by INSEEGO CORP as beta site test samples, experimental, developmental, reproduction, sample, incomplete or out of specification Products, or (VIII) returned products if the original identification marks have been removed or altered. There is no warranty that information stored in the Product will be retained following any Product repair or replacement.

EXCEPT AS PROVIDED IN THIS WARRANTY AND TO THE MAXIMUM EXTENT PERMITTED BY LAW, INSEEGO CORP IS NOT RESPONSIBLE FOR DIRECT, SPECIAL, INCIDENTAL OR CONSEQUENTIAL DAMAGES RESULTING FROM ANY BREACH OF WARRANTY OR CONDITION, OR UNDER ANY OTHER LEGAL THEORY.

THE FOREGOING LIMITATION SHALL NOT APPLY TO DEATH OR PERSONAL INJURY CLAIMS, OR ANY STATUTORY LIABILITY FOR INTENTIONAL AND GROSS NEGLIGENT ACTS AND/OR OMISSIONS. SOME STATES (COUNTRIES AND PROVINCES) DO NOT ALLOW THE EXCLUSION OR LIMITATION OF INCIDENTAL OR CONSEQUENTIAL DAMAGES, SO THE ABOVE LIMITATION OR EXCLUSION MAY NOT APPLY TO YOU.

Safety Hazards

Do not operate the S2000e in an environment that might be susceptible to radio interference resulting in danger, specifically:

Areas where prohibited by the law

Follow any special rules and regulations and obey all signs and notices. Always turn off the host device when instructed to do so, or when you suspect that it might cause interference or danger.

Where explosive atmospheres might be present

Do not operate your device in any area where a potentially explosive atmosphere might exist. Sparks in such areas could cause an explosion or fire resulting in bodily injury or even death. Be aware and comply with all signs and instructions.

Users are advised not to operate the device while at a refueling point or service station. Users are reminded to observe restrictions on the use of radio equipment in fuel depots (fuel storage and distribution areas), chemical plants or where blasting operations are in progress.

Areas with a potentially explosive atmosphere are often but not always clearly marked. Potential locations can include gas stations, below deck on boats, chemical transfer or storage facilities, vehicles using liquefied petroleum gas (such as propane or butane), areas where the air contains chemicals or particles, such as grain, dust or metal powders, and any other area where you would normally be advised to turn off your vehicle engine.

Near medical and life support equipment

Do not operate your device in any area where medical equipment, life support equipment, or near any equipment that might be susceptible to any form of radio interference. In such areas, the host communications device must be turned off. The device can transmit signals that could interfere with this equipment.

On an aircraft, either on the ground or airborne

In addition to FAA requirements, many airline regulations state that you must suspend wireless operations before boarding an airplane. Please ensure that the modem is turned off prior to boarding aircraft in order to comply with these regulations. The modem can transmit signals that could interfere with various onboard systems and controls.

While operating a vehicle

The driver or operator of any vehicle should not operate a wireless data device while in control of a vehicle. Doing so will detract from the driver or operator's control and operation of that vehicle. In some countries, operating such communications devices while in control of a vehicle is an offense.

Electrostatic Discharge (ESD)

Electrical and electronic devices are sensitive to electrostatic discharge (ESD). Macintosh native connection software might attempt to reinitialize the device should a substantial electrostatic discharge reset the device. If the software is not operational after an ESD occurrence, then restart your computer.

6

Glossary

Glossary

- **4G LTE**—Fourth Generation Long Term Evolution. LTE is a standard for wireless data communications technology and an evolution of the GSM/UMTS standards. The goal of LTE is to increase the capacity and speed of wireless data networks using new DSP (digital signal processing) techniques and modulations that were developed around the turn of the millennium. A further goal is the redesign and simplification of the network architecture to an IP-based system with significantly reduced transfer latency compared to the 3G architecture. The LTE wireless interface is incompatible with 2G and 3G networks, so that it must be operated on a separate wireless spectrum
- **5G**—Fifth Generation. The successor to 4GLTE technology, offering greater bandwidth and higher download speeds. In addition to serving cellular networks, 5G networks can be used as internet service providers, competing with other ISPs. 5G also opens up new IoT and M2M possibilities. Wireless devices must be 5G enabled to use 5G networks.
- **APN** — Access Point Name. The name of a gateway between a mobile network and another computer network, often the Internet.
- **bps** — Bits per second. The rate of data flow.
- **Broadband** — High-capacity high-speed transmission channel with a wider bandwidth than conventional modem lines. Broadband channels can carry video, voice, and data simultaneously.
- **DHCP** — Dynamic Host Configuration Protocol. Software found in servers and routers that automatically assigns IP addresses and other configuration data to computers, tablets, printers, and other devices connection to the IP network.
- **DHCP Server** — A server or service with a server that assigns IP addresses.
- **DMZ** — DeMilitarized Zone. A sub-network that contains and exposes an organization's external-facing services to an untrusted network, usually a larger network such as the Internet.
- **DNS** — Domain Name System. A system for converting host names and domain names into IP addresses on the Internet or on local networks that use the TCP/IP protocol.
- **Firmware** — A computer program embedded in an electronic device. Firmware usually contains operating code for the device.
- **FTP** — File Transfer Protocol. A standard network protocol used to transfer computer files between a client and server.
- **GB**—Gigabyte. A multiple of the unit byte for digital information storage. Usage depends on context. When referring to disk capacities it usually means 10^9 bytes. It also applies to data transmission quantities over telecommunication circuits.
- **Gbps** — Gigabits per second. The rate of data flow.
- **HTTP**—Hypertext Transfer Protocol. An application-level protocol for accessing the World Wide Web over the Internet.

- **IEEE** — Institute of Electrical and Electronics Engineers. An international technical/professional society that promotes standardization in technical disciplines.
- **IMAP** — Internet Message Access Protocol. An Internet standard protocol for accessing email from a remote server from email clients. IMAP allows access from multiple client devices.
- **IMEI** — International Mobile Equipment Identity. Used in mobile networks to identify the device. It is usually printed on the device and can often be retrieved using a USSD code.
- **IP** — Internet Protocol. The mechanism by which packets are routed between computers on a network.
- **IP address** — Internet Protocol address. The address of a device attached to an IP network (TCP/IP network).
- **ISP** — Internet Service Provider. Also referred to as the service carrier, an ISP provides Internet connection service (See Network Operator).
- **Kbps** — Kilobits per second. The rate of data flow.
- **LAN** — Local Area Network. A type of network that lets a group of computers, all in close proximity (such as inside an office building), communicate with one another. It does not use common carrier circuits though it can have gateways or bridges to other public or private networks.
- **MAC Address** — Media Access Control. A number that uniquely identifies each network hardware device. MAC addresses are 12-digit hexadecimal numbers. This is also known as the physical or hardware address.
- **Mbps** — Megabits per second. The rate of data flow.
- **Network Operator** — The vendor that provides your wireless access. Known by different names in different regions, some examples are: wireless provider, network provider, or cellular carrier.
- **Network Technology** — The technology on which a particular network provider's system is built; such as LTE or GSM.
- **NNTP** — Network News Transfer Protocol. The primary protocol used to connect to Usenet servers and transfer news articles between systems over the Internet.
- **POP3** — Post Office Protocol 3. A protocol in which email is received and held for you by your Internet server until you download it.
- **Port** — A virtual data connection used by programs to exchange data. It is the endpoint in a logical connection. The port is specified by the port number.
- **Port Forwarding** — A process that allows remote devices to connect to a specific computer within a private LAN.
- **Port Number** — A 16-bit number used by the TCP and UDP protocols to direct traffic on a TCP/IP host. Certain port numbers are standard for common applications.

- **Protocol** — A standard that enables connection, communication, and data transfer between computing endpoints.
- **Proxy** — A firewall mechanism that replaces the IP address of a host on the internal (protected) network with its own IP address for all traffic passing through it.
- **Router** — A device that directs traffic from one network to another.
- **RSSI** — Received Signal Strength Indicator. An estimated measure of how well a device can hear a signal from an access point or router. RSSI value is pulled from the device's Wi-Fi card (hence "received" signal strength), so it is not the same as transmit power from an access point or router.
- **SIM** — Subscriber Identification Module. Found in LTE and GSM network technology, the SIM is a card containing identification information for the subscriber and their account. The SIM card can be moved to different devices.
- **SMTP** — Simple Mail Transfer Protocol. The standard protocol for sending emails across the Internet.
- **SNMP** — Simple Network Management Protocol. An Internet protocol used to manage and monitor network devices and their functions.
- **SSID** — Service Set Identifier. The name assigned to a Wi-Fi network.
- **TCP/IP** — Transmission Control Protocol/Internet Protocol. The set of communications protocols used for the Internet and other similar networks.
- **TFTP** — Trivial File Transfer Protocol. An Internet software utility for transferring files that is simpler to use than FTP, but does not provide user authentication and directory visibility supported by FTP.
- **Telnet** — A user command and underlying TCP/IP protocol that allows a user on one computer to log into another computer that is part of the same network.
- **UDP** — User Datagram Protocol (UDP) is a communications protocol that offers a limited amount of service when messages are exchanged between computers in a network that uses the Internet Protocol (IP). UDP is an alternative to the Transmission Control Protocol (TCP) and, together with IP, is sometimes referred to as UDP/IP.
- **USSD** — Unstructured Supplementary Service Data (USSD), also known as "Quick code" or "Feature code", is a communications protocol used to send data between a mobile device and network service provider.
- **VPN** — Virtual Private Network. A secure private network that runs over the public Internet. Commonly used to connect to an office network from elsewhere.